

Genuine Value Retail Sales Guide



www.midwestdesignersupply.com

888-523-2611
262-524-1007 (fax)

genesis®



Custom Window Shades
Shade Masterpieces™ Custom Window Shades
Season-View™ Shades
Flat Roman Shades
Panel Track System

Custom Crafted in the U.S.A.



March 27, 2018

Electronic update May 31, 2018

Prices subject to change without notice

Customer assumes all responsibilities for phone orders.
Due to custom nature of our business,
orders cannot be cancelled after materials have been cut.

Table of Contents

	PAGE
Fabric Information & Specifications	
Fabric Information	3-4
Window Shade Size Standards	5-12
Motorized Window Shade Size Standards	13-20
Window Shade Design Options Cross Reference	21
Screen Shade Quick Reference	22
Roman Shade Size Standards	23
Motorized Roman Shade Size Standards	24
Roman Shade Design Options Cross Reference	25
Panel Track Size Standards	25
Pricing	
Window Shade Pricing	26-29
Window Shade Options & Surcharges	30-31
Window Shade Motorization Pricing	32-33
Shade Masterpieces & COM Window Shade Pricing	34-35
Flat Roman Shade Pricing	36-37
Flat Roman Shade Options and Surcharges	38
Panel Track Pricing	39-40
Window Shade Product Information	
Window Shade with Clutch System	41
Window Shade with Decorative Clutch	42
Auto-Wand™ Window Shade Motorization	43
Somfy® Motorization Systems	44-45
EZ Charge™ Rechargeable Motorization Series	46-47
QMotion® Window Shade Motorization	48-49
Sure-Lift™ Retractable Pull Cord Version 2.0	50
EZ Pull™	51
EZ Lift™	52
Spring Roller	53
Top Down Window Shade	54
Light Blockout System	55
Season-Vue™ Window Shades	56-57
Design Options - Cassettes	58
Design Options - Fascia and Pocket Systems	59
Design Options - Board Mounted Shades	60
Design Options - Window Shade Valances, Hemlines	61-65
Design Options - Other Options	66
Bracket Information, Tube Sizes, Measuring and Operation	67-68
Genesis Shade Masterpieces and COM Window Shades	69
Flat Roman Shade Product Information	
Flat Roman Shades	70
CareRING™ Cordless System and TLC™ Child Safety	71
Flat Roman Specialties	72-73
Design Options - Flat Roman Shades	74-75
Panel Track Product Information and Design Options	76-79
Terminology and Glossary	80-81
Genesis Color Listing & Component Coordination	82-84

Product Index

Genesis Fabric Information

Fabric Name	WS/RS Price Chart	Fabric Information							Window Shades & Roman Shades					Panel Track Price Chart
		Fabric Width	Available Railroaded	Openness %	Opacity Level	# of Colors	FR Code♦	Eco Friendly	Dec Hem	Season Vue	Companion Fabric	Flat Roman	Specialty Shapes	
Adele	5	110"			2	2	NFPA701		✓			✓	✓	4
Aedan	6	79"			3	2		Oeko-tex 100	✓					5
Beatty	6	72"			2	1		Oeko-tex 100	✓			✓	✓	5
Berber Slub	6	72"			2	3		Oeko-tex 100			Discoveries	✓	✓	5
Boho	7	94"			1	1		Greenguard	✓			✓		5
Boucle	2	72"			5	1	NFPA 701	Greenguard	✓	✓				N/A
Brit	6	98"		5%		2	NFPA 701	Greenguard		✓				5
Cabos	5	108"			1	4		Oeko-tex 100			Discoveries	✓	✓	N/A
Cayman	5	110"			2	2			✓			✓	✓	4
Charmed	3	110"			3	1					Allure	✓		2
Dakota	6	90"			3	1			✓			✓	✓	5
Dallas	6	72"			2	2		Oeko-tex 100	✓			✓	✓	4
Deco Screen	6	98"		5%		1	NFPA 701	Greenguard		✓				4
Dimensions (3%)	3	120"		3%		8	NFPA 701	Greenguard		✓		✓	✓	2
Dimensions (5%)	3	120"		5%		8	NFPA 701	Greenguard		✓		✓	✓	2
Duo Vue	4	98"		1%		3	NFPA 701	Greenguard		✓				3
E Screen (3%)	3	122"		3%		7	NFPA 701	Greenguard		✓		✓	✓	N/A
E Screen (5%)	3	122"		5%		7	NFPA 701	Greenguard		✓		✓	✓	N/A
E Screen KOOLBLACK® (3%)	6	122"		3%		3	NFPA 701	Greenguard		✓		✓	✓	N/A
E Screen KOOLBLACK® (5%)	6	122"		5%		3	NFPA 701	Greenguard		✓		✓	✓	N/A
Economy Screen	A	118"		7%		3	NFPA 701	Greenguard						N/A
Fedora	6	72"			2	3		Oeko-tex 100	✓			✓	✓	4
Fiber-Lucent	1	72"	✓		3	2	NFPA 701	Greenguard	✓	✓				1
Flutter	4	96"			3	3					Allure	✓	✓	N/A
Garbo	4	110"			3	3					Allure	✓		2
Grasscloth	6	72"			3	3		Oeko-tex 100	✓			✓	✓	4
Harper	6	115"			3	1		Greenguard	✓					5
Highland	6	118"			5	3	NFPA 701	PVC/Lead Free	✓					N/A
Hombre	6	72"			2	3		Oeko-tex 100	✓		Discoveries	✓	✓	4
Homespun	5	79"			2	2		Oeko-tex 100	✓			✓	✓	4
Jackson	6	72"			2	4			✓			✓	✓	5
Katrina	1	98"			2	1			✓					N/A
Keilani	5	108"			2	2		Oeko-tex 100				✓	✓	N/A
Kendo	7	94"			1	2						✓	✓	N/A
Lexie	6	110"			2	3		PVC Free	✓					N/A
Light-Vue	5	72"	✓		1	3								N/A
Lindley	7	72"			5	3			✓					N/A
Linen	4	78"			5	2			✓					N/A
Lizzy	6	86"			3	2			✓			✓	✓	5
Long Bay	3	110"			3	5			✓			✓		2
Long Bay Blackout	6	106"			5	2			✓					5
Loretta	5	72"			2	1		Oeko-tex 100	✓			✓	✓	4
Lucinda	5	72"			2	1		Oeko-tex 100	✓					4
Luminescence	6	94"			3	5					Allure			N/A
Lux Screen	4	98"		3%		3	NFPA 701			✓		✓	✓	3
Moire	2	72"			5	1	NFPA 701	Greenguard	✓	✓				N/A
Mystic	4	108"			3	12					Allure	✓		3
Mystic Eclipse	6	110"			5	5			✓		Allure			5
Net 3000	2	118"	✓	5%		7	NFPA 701	Greenguard		✓		✓	✓	1
No-Lite Fiberglass Duplex	2	72"	✓		5	4	NFPA 701	Greenguard	✓	✓				N/A
No-Lite Fiberglass Solids	1	72"	✓		5	6	NFPA 701	Greenguard	✓	✓				N/A
Nordicscreen Plus BW 3%	2	118"		3%		9	NFPA 701	Greenguard		✓				2
Nordicscreen Plus BW 5%	2	118"		5%		10	NFPA 701	Greenguard		✓				1
Nordicscreen Plus Twill 1%	3	118"		1%		7	NFPA 701	Greenguard		✓				2
Nordicscreen Plus Twill 3%	2	118"		3%		4	NFPA 701	Greenguard		✓				2
Opulence	3	118"		10%		4	NFPA 701	Greenguard		✓				2
Origami	5	108"			1	1		Oeko-tex 100				✓	✓	N/A

♦ For fabrics that are not FR rated, see Design Options on [page 66](#) for FR Coating or Antimicrobial Coating information.

Pricing for window height up to 120" is provided. For shades greater than 120" window height a different tube size may be required. Contact Customer Service for size/tube availability greater than 120" window height.

For **Window Shades - Railroaded Fabric** - Shades fabricated wider than the maximum shade width are made with fabric turned width for length. Railroaded shades may have a visible horizontal seam if requested length exceeds fabric width.

Product Index

Genesis Fabric Information

Fabric Name	WS/RS Price Chart	Fabric Information							Window Shades & Roman Shades					Panel Track Price Chart	
		Fabric Width	Available Railroaded	Openness %	Opacity Level	# of Colors	FR Code♦	Eco Friendly	Dec Hem	Season Vue	Companion Fabric	Flat Roman	Specialty Shapes		
Pacifica	9	110"			5	2	NFPA 701	Greenguard	✓						N/A
Palm Beach	6	118"			5	3			✓						N/A
Pearlescent	4	78"	✓		5	2			✓						N/A
Persia	5	110"			2	2			✓			✓	✓		3
Petticoat	5	110"			2	1									N/A
Princeton	3	78"			3/4	4			✓						1
Reserved	6	94"			4	2					Allure				N/A
Rocky Mountain	4	70"			2	3		Oeko-tex 100	✓			✓	✓		4
Rollie	6	79"	✓		2	1		Oeko-tex 100	✓						5
S Screen Elements	5	122"		4%		1	NFPA 701	Greenguard		✓					4
S Screen Origins	5	122"		4%		2	NFPA 701	Greenguard		✓					4
Safari	6	72"			2	1		Oeko-tex 100							N/A
Scala Blackout	2	110"			3	4			✓						N/A
Seclusion	6	120"	✓		5	1	NFPA 701	Greenguard	✓	✓					N/A
Sedona	6	110"			5	4		PVC/Lead Free	✓						5
Serene	2	98"			5	7			✓		Allure				N/A
Seto 5000	4	110"			3	2	NFPA 701	Oeko-tex 100	✓						N/A
Seto 6000	4	110"			2	2	NFPA 701	Oeko-tex 100	✓						N/A
Shantung	6	79"			3	2		Oeko-tex 100	✓			✓	✓		4
SheerWeave 1000	2	96"		25%		1	NFPA 701	Greenguard				✓	✓		N/A
SheerWeave 2000	3	126"	✓	5%		8	NFPA 701	Greenguard		✓		✓	✓		2
SheerWeave 2390	3	126"	✓	5%		6	NFPA 701	Greenguard		✓		✓	✓		2
SheerWeave 2410	4	126"	✓	3%		6	NFPA 701	Greenguard		✓		✓	✓		3
SheerWeave 2500	5	126"	✓	1%		6	NFPA 701	Greenguard		✓		✓	✓		4
SheerWeave 3000	3	96"		14%		6	NFPA 701	Greenguard		✓		✓	✓		2
SheerWeave 4100	3	98"	✓	10%		6	NFPA 701	Greenguard		✓					2
SheerWeave 4400	4	126"		3%		2	NFPA 701	Greenguard		✓					3
SheerWeave 5000 *	4	98"		1/3/5/7/10%		24	See Page 22	Greenguard		✓					3
SheerWeave 7000	7	118"	✓		5	7	NFPA 701	Greenguard	✓	✓					5
SheerWeave 7400	6	118"			5	5	NFPA701	Greenguard	✓						5
SheerWeave 7450	4	118"			3	3	CA 117E	Greenguard	✓			✓	✓		3
SheerWeave Infinity 2 (3%)	7	98"		3%		3	NFPA 701	Greenguard		✓					6
SheerWeave Infinity 2 (5%)	7	98"		5%		3	NFPA 701	Greenguard		✓					6
SheerWeave Perf+ 2390	9	96"		5%		3	NFPA 701	Greenguard		✓					6
SheerWeave Perf+ 2410	9	96"		3%		3	NFPA 701	Greenguard		✓					6
Solar Screen 3000 1%	2	118"		1%		7	NFPA 701			✓					1
Solar Screen 3000 3%	2	118"		3%		8	NFPA 701			✓					1
Spector	7	84"			5	7	NFPA701		✓						5
Spiral	4	102"			4	2		Oeko-tex 100	✓						3
Strata	8	81"			3	2	NFPA 701		✓						N/A
Strie	6	72"			2	3		Oeko-tex 100	✓		Discoveries	✓	✓		5
SuperWide	6	106"	✓		5	3			✓						N/A
T Screen KOOLBLACK® (3%)	5	122"		3%		3	NFPA701	Greenguard		✓		✓	✓		4
T Screen KOOLBLACK® (5%)	5	122"		5%		3	NFPA701	Greenguard		✓		✓	✓		4
Tahiti	8	70"			3	3						✓	✓		N/A
Triad	4	118"		3%		5	NFPA 701	Greenguard		✓					2
Tussah	5	110"			2/3	5		PVC Free	✓						N/A
Valencia	8	94"			3	2		Oeko-tex 100	✓						6
Viking	1	72"	✓		3	6	NFPA 701	Greenguard	✓						N/A
Vision	1	118"		5%		4	NFPA 701	Oeko-tex 100		✓					N/A
Vista Screen	7	98"		4%		4	NFPA701	Oeko-tex 100		✓		✓	✓		5
Vizela	8	94"			2	2	NFPA 701	Greenguard	✓			✓	✓		6
Wave	7	72"			3	1		Oeko-tex 100	✓						5
Weave	6	72"			2	3		Oeko-tex 100			Discoveries				5
Willow	6	72"			2	3		Oeko-tex 100	✓			✓	✓		4
Yellowstone	4	72"			3	5		Oeko-tex 100	✓		Discoveries	✓			4
Zootime	7	86"			5	1			✓						N/A

♦ For fabrics that are not FR rated, see Design Options on [page 66](#) for FR Coating or Antimicrobial Coating information.

* SheerWeave 5000 openness varies by color; See the Genesis sample book or [page 22](#) for listing of colors/openness.

Pricing for window height up to 120" is provided. For shades greater than 120" window height a different tube size may be required. Contact Customer Service for size/tube availability greater than 120" window height.

For **Window Shades - Railroaded Fabric** - Shades fabricated wider than the maximum shade width are made with fabric turned width for length. Railroaded shades may have a visible horizontal seam if requested length exceeds fabric width.

Size Standards Window Shades

		SL & R Clutch Page 41	Luxe™ Clutch Page 42	Sure- Lift™ Page 50	EZ Pull™ Page 51	EZ Lift™ Page 52	Small Cassette Page 58	Large Cassette Page 58	Board Mounted Page 60
Adele	Max Width / Max Height Max Sq Ft	110" / 120"	103" / 96"	84" / 84"	N/A	N/A	96" / 108" 56	110" / 120" 80	95" / 120"
Aedan	Max Width / Max Height Max Sq Ft	79" / 120"	79" / 96"	79" / 84"	79" / 96"	72" / 96"	79" / 102" 55	79" / 120" 65	70" / 120"
Beatty - Serged Edge	Max Width / Max Height Max Sq Ft	72" / 120"	72" / 96"	72" / 72"	72" / 96"	72" / 96"	72" / 50" 25	72" / 96" 48	63" / 120"
Berber Slub	Max Width / Max Height Max Sq Ft	72" / 120"	72" / 96"	72" / 84"	72" / 96"	72" / 96"	72" / 90" 42	72" / 108" 54	63" / 120"
Boho	Max Width / Max Height Max Sq Ft	94" / 120"	94" / 96"	84" / 84"	94" / 96"	72" / 96"	94" / 102" 56	94" / 120" 78	85" / 120"
Boucle	Max Width / Max Height Max Sq Ft	72" / 120"	72" / 96"	72" / 84"	72" / 96"	72" / 96"	72" / 102" 51	72" / 120" 60	63" / 120"
Brit	Max Width / Max Height Max Sq Ft	98" / 120"	98" / 96"	84" / 84"	96" / 96"	72" / 96"	96" / 102" 56	98" / 120" 80	89" / 120"
Cabos	Max Width / Max Height Max Sq Ft	108" / 120"	103" / 96"	84" / 84"	96" / 96"	72" / 96"	96" / 72" 48	108" / 96" 72	95" / 120"
Cayman	Max Width / Max Height Max Sq Ft	110" / 120"	103" / 96"	84" / 84"	N/A	N/A	96" / 72" 48	110" / 102" 75	95" / 120"
Charmed	Max Width / Max Height Max Sq Ft	110" / 120"	103" / 96"	84" / 84"	N/A	N/A	96" / 102" 56	110" / 120" 80	95" / 120"
Dakota	Max Width / Max Height Max Sq Ft	90" / 120"	90" / 96"	84" / 84"	90" / 96"	72" / 96"	90" / 72" 45	90" / 96" 60	81" / 120"
Dallas	Max Width / Max Height Max Sq Ft	72" / 120"	72" / 96"	72" / 84"	72" / 96"	72" / 96"	72" / 96" 48	72" / 108" 54	63" / 120"
Deco Screen	Max Width / Max Height Max Sq Ft	98" / 120"	98" / 96"	84" / 84"	96" / 96"	72" / 96"	96" / 96" 56	98" / 102" 68	89" / 120"
Dimensions 3%	Max Width / Max Height Max Sq Ft	120" / 120"	103" / 96"	84" / 84"	96" / 96"	72" / 96"	96" / 96" 48	120" / 108" 80	95" / 120"
Dimensions 5%	Max Width / Max Height Max Sq Ft	120" / 120"	103" / 96"	84" / 84"	96" / 96"	72" / 96"	96" / 96" 48	120" / 102" 68	95" / 120"
Duo Vue	Max Width / Max Height Max Sq Ft	98" / 120"	98" / 96"	84" / 84"	96" / 96"	72" / 96"	96" / 72" 48	98" / 96" 65	89" / 120"
E Screen 3% or 5%	Max Width / Max Height Max Sq Ft	122" / 120"	103" / 96"	84" / 84"	96" / 96"	72" / 96"	96" / 96" 48	120" / 108" 68	95" / 120"
E Screen with KOOLBLACK™ Technology 3% or 5%	Max Width / Max Height Max Sq Ft	122" / 120"	103" / 96"	84" / 84"	96" / 96"	72" / 96"	96" / 96" 48	120" / 108" 68	95" / 120"
Economy Screen	Max Width / Max Height Max Sq Ft	118" / 120"	103" / 96"	84" / 84"	96" / 96"	72" / 96"	96" / 96" 48	118" / 108" 68	95" / 120"
Fedora - Serged Edge	Max Width / Max Height Max Sq Ft	72" / 120"	72" / 96"	72" / 84"	72" / 96"	72" / 96"	72" / 96" 48	72" / 120" 60	63" / 120"
Fiber-Lucent	Max Width / Max Height Max Sq Ft	120** / 120"	103** / 96"	84" / 84"	96** / 96"	72" / 96"	96" / 108" 56	120** / 120" 80	95** / 120"
Flutter	Max Width / Max Height Max Sq Ft	96" / 120"	96" / 96"	84" / 84"	N/A	N/A	96" / 102" 56	96" / 120" 80	87" / 120"
Garbo	Max Width / Max Height Max Sq Ft	110" / 120"	103" / 96"	84" / 84"	N/A	N/A	96" / 96" 56	110" / 108" 72	95" / 120"
Grasscloth	Max Width / Max Height Max Sq Ft	72" / 120"	72" / 96"	72" / 84"	72" / 96"	72" / 96"	72" / 96" 48	72" / 108" 54	63" / 120"
Harper	Max Width / Max Height Max Sq Ft	115" / 120"	103" / 96"	84" / 84"	94" / 96"	72" / 96"	96" / 96" 56	115" / 108" 76	95" / 120"
Highland	Max Width / Max Height Max Sq Ft	118" / 120"	103" / 96"	84" / 84"	96" / 96"	72" / 96"	96" / 96" 56	118" / 108" 76	95" / 120"
	Minimum Width	15"	15"	15"	30 1/2"	18 1/2"♦	15"	15"	15"
	Minimum Height	24"	24"	24"	24"	24"	24"	24"	24"

* Railroading this fabric results in a larger maximum width than the fabric width.

♦ For widths 18 1/2" to 26 1/2", shades are available up to 56" long.

For shades greater than 120" window height a different tube size may be required. Contact Customer Service for shades over 120" window height.

Size Standards Window Shades

		SL & R Clutch Page 41	Luxe™ Clutch Page 42	Sure- Lift™ Page 50	EZ Pull™ Page 51	EZ Lift™ Page 52	Small Cassette Page 58	Large Cassette Page 58	Board Mounted Page 60
Hombre - Serged Edge	Max Width / Max Height Max Sq Ft	72" / 120"	72" / 96"	72" / 84"	72" / 96"	72" / 96"	72" / 108" 54	72" / 120" 60	63" / 120"
Homespun	Max Width / Max Height Max Sq Ft	79" / 120"	79" / 96"	79" / 84"	79" / 96"	72" / 96"	79" / 86" 52	79" / 108" 58	70" / 120"
Jackson	Max Width / Max Height Max Sq Ft	72" / 120"	72" / 96"	72" / 72"	NA	NA	72" / 48" 24	72" / 72" 36	63" / 120"
Katrina	Max Width / Max Height Max Sq Ft	98" / 120"	98" / 96"	84" / 84"	96" / 96"	72" / 96"	96" / 96" 48	98" / 108" 68	89" / 120"
Keilani	Max Width / Max Height Max Sq Ft	108" / 120"	103" / 96"	84" / 84"	96" / 96"	72" / 96"	96" / 72" 40	108" / 102" 74	95" / 120"
Kendo	Max Width / Max Height Max Sq Ft	94" / 120"	94" / 96"	84" / 84"	94" / 96"	72" / 96"	94" / 96" 56	94" / 108" 68	85" / 120"
Lexie	Max Width / Max Height Max Sq Ft	110" / 120"	103" / 96"	84" / 84"	96" / 96"	72" / 96"	96" / 102" 56	110" / 120" 80	95" / 120"
Light-Vue	Max Width / Max Height Max Sq Ft	192** / 120"	103** / 96"	84" / 84"	96** / 96"	72" / 96"	96** / 96" 56	120** / 120" 80	95** / 120"
Lindley - Serged Edge	Max Width / Max Height Max Sq Ft	72" / 120"	72" / 96"	72" / 84"	72" / 96"	72" / 96"	72" / 72" 36	72" / 96" 48	63" / 120"
Linen	Max Width / Max Height Max Sq Ft	78" / 120"	78" / 96"	78" / 84"	78" / 96"	72" / 96"	78" / 108" 56	78" / 120" 65	69" / 120"
Lizzy	Max Width / Max Height Max Sq Ft	86" / 120"	86" / 96"	86" / 84"	86" / 96"	72" / 96"	86" / 102" 56	86" / 120" 70	77" / 120"
Long Bay	Max Width / Max Height Max Sq Ft	110" / 120"	103" / 96"	84" / 84"	96" / 96"	72" / 96"	96" / 108" 56	110" / 120" 80	95" / 120"
Long Bay Blackout	Max Width / Max Height Max Sq Ft	106" / 120"	103" / 96"	84" / 84"	NA	NA	96" / 90" 56	106" / 108" 76	95" / 120"
Loretta	Max Width / Max Height Max Sq Ft	72" / 120"	72" / 96"	72" / 84"	72" / 96"	72" / 96"	72" / 102" 51	72" / 120" 60	63" / 120"
Lucinda	Max Width / Max Height Max Sq Ft	72" / 120"	72" / 96"	72" / 84"	72" / 96"	72" / 96"	72" / 96" 48	72" / 108" 54	63" / 120"
Luminescence	Max Width / Max Height Max Sq Ft	94" / 120"	94" / 96"	84" / 84"	NA	NA	94" / 102" 56	94" / 120" 78	85" / 120"
Lux Screen	Max Width / Max Height Max Sq Ft	98" / 120"	98" / 96"	84" / 84"	96" / 96"	72" / 96"	96" / 72" 48	98" / 96" 64	89" / 120"
Moire	Max Width / Max Height Max Sq Ft	72" / 120"	72" / 96"	72" / 84"	72" / 96"	72" / 96"	72" / 108" 54	72" / 120" 60	63" / 120"
Mystic	Max Width / Max Height Max Sq Ft	108" / 120"	103" / 96"	84" / 84"	96" / 96"	72" / 96"	96" / 102" 56	108" / 120" 80	95" / 120"
Mystic Eclipse	Max Width / Max Height Max Sq Ft	110" / 120"	103" / 96"	84" / 84"	84" / 96"	72" / 96"	96" / 84" 56	110" / 120" 80	95" / 120"
Net 3000	Max Width / Max Height Max Sq Ft	192** / 120"	103" / 96"	84" / 84"	96" / 96"	72" / 96"	96" / 108" 48	120** / 120" 80	95" / 120"
No-Lite Fiberglass - Duplex and Solids	Max Width / Max Height Max Sq Ft	192** / 120"	103** / 96"	84** / 84"	96** / 96"	72" / 96"	96** / 120" 56	120** / 120" 80	95** / 120"
Nordicscreen Plus BW - 3% or 5%	Max Width / Max Height Max Sq Ft	118" / 168"	103" / 96"	84" / 84"	96" / 96"	72" / 96"	96" / 84" 48	118" / 108" 64	95" / 120"
Nordicscreen Plus Twill - 1% or 3%	Max Width / Max Height Max Sq Ft	118" / 168"	103" / 96"	84" / 84"	96" / 96"	72" / 96"	96" / 84" 48	118" / 108" 64	95" / 120"
Opulence	Max Width / Max Height Max Sq Ft	118" / 120"	103" / 96"	84" / 84"	96" / 96"	72" / 96"	96" / 72" 48	118" / 96" 75	95" / 120"
Origami	Max Width / Max Height Max Sq Ft	108" / 120"	103" / 96"	84" / 84"	96" / 96"	72" / 96"	96" / 96" 48	108" / 108" 72	95" / 120"
Pacifica	Max Width / Max Height Max Sq Ft	110" / 120"	103" / 96"	84" / 84"	N/A	N/A	96" / 102" 56	110" / 120" 80	95" / 120"
	Minimum Width	15"	15"	15"	30 1/2"	18 1/2"♦	15"	15"	15"
	Minimum Height	24"	24"	24"	24"	24"	24"	24"	24"

* Railroading this fabric results in a larger maximum width than the fabric width.

♦ For widths 18 1/2" to 26 1/2", shades are available up to 56" long.

For shades greater than 120" window height a different tube size may be required. Contact Customer Service for shades over 120" window height.

Size Standards Window Shades

		SL & R Clutch Page 41	Luxe™ Clutch Page 42	Sure- Lift™ Page 50	EZ Pull™ Page 51	EZ Lift™ Page 52	Small Cassette Page 58	Large Cassette Page 58	Board Mounted Page 60
Palm Beach	Max Width / Max Height Max Sq Ft	118" / 120"	103" / 96"	84" / 84"	96" / 96"	72" / 96"	96" / 84" 48	118" / 102" 80	95" / 120"
Pearlescent	Max Width / Max Height Max Sq Ft	192** / 120"	103** / 96"	84** / 84"	96** / 96"	72" / 96"	96** / 102" 56	120** / 120" 80	95** / 120"
Persia	Max Width / Max Height Max Sq Ft	110" / 120"	103" / 96"	84" / 84"	N/A	N/A	96" / 84" 56	110" / 120" 80	95" / 120"
Petticoat	Max Width / Max Height Max Sq Ft	110" / 120"	103" / 96"	84" / 84"	96" / 96"	72" / 96"	96" / 72" 48	110" / 96" 72	95" / 120"
Princeton	Max Width / Max Height Max Sq Ft	78" / 120"	78" / 96"	78" / 84"	78" / 96"	72" / 96"	78" / 114" 55	78" / 120" 65	69" / 120"
Reserved	Max Width / Max Height Max Sq Ft	94" / 120"	94" / 96"	84" / 84"	N/A	N/A	94" / 96" 56	94" / 108" 70	85" / 120"
Rocky Mountain - Serged Edge	Max Width / Max Height Max Sq Ft	70" / 120"	70" / 96"	70" / 84"	70" / 96"	70" / 96"	70" / 72" 35	70" / 102" 48	61" / 120"
Rollie - Serged Edge	Max Width / Max Height Max Sq Ft	192** / 120"	103** / 96"	84** / 84"	96** / 96"	72" / 96"	96** / 96" 56	120** / 120" 80	95** / 120"
S Screen Elements	Max Width / Max Height Max Sq Ft	122" / 120"	103" / 96"	84" / 84"	96" / 96"	72" / 96"	96" / 60" 40	120" / 96" 72	95" / 120"
S Screen Origins	Max Width / Max Height Max Sq Ft	122" / 120"	103" / 96"	84" / 84"	96" / 96"	72" / 96"	96" / 60" 40	120" / 96" 72	95" / 120"
Safari	Max Width / Max Height Max Sq Ft	72" / 120"	72" / 96"	72" / 84"	72" / 96"	72" / 96"	72" / 72" 36	72" / 96" 48	63" / 120"
Scala Blackout	Max Width / Max Height Max Sq Ft	110" / 168"	103" / 96"	84" / 84"	96" / 96"	72" / 96"	96" / 96" 48	110" / 120" 64	95" / 120"
Seclusion	Max Width / Max Height Max Sq Ft	192** / 120"	103" / 96"	84" / 84"	96" / 96"	72" / 96"	96" / 96" 56	120" / 120" 80	95" / 120"
Sedona	Max Width / Max Height Max Sq Ft	110" / 120"	103" / 96"	84" / 84"	N/A	N/A	96" / 90" 56	110" / 108" 80	95" / 120"
Serene	Max Width / Max Height Max Sq Ft	98" / 120"	98" / 96"	84" / 84"	96" / 96"	72" / 96"	96" / 108" 56	98" / 120" 80	89" / 120"
Seto 5000	Max Width / Max Height Max Sq Ft	110" / 120"	103" / 96"	84" / 84"	96" / 96"	72" / 96"	96" / 102" 56	110" / 120" 80	95" / 120"
Seto 6000	Max Width / Max Height Max Sq Ft	110" / 120"	103" / 96"	84" / 84"	96" / 96"	72" / 96"	96" / 96" 48	110" / 108" 72	95" / 120"
Shantung	Max Width / Max Height Max Sq Ft	79" / 120"	79" / 96"	79" / 84"	79" / 96"	72" / 96"	79" / 84" 46	79" / 96" 52	70" / 120"
SheerWeave 1000	Max Width / Max Height Max Sq Ft	96" / 120"	96" / 96"	84" / 84"	96" / 96"	72" / 96"	96" / 96" 56	96" / 108" 72	87" / 120"
SheerWeave 2000	Max Width / Max Height Max Sq Ft	192** / 120"	103" / 96"	84" / 84"	96" / 96"	72" / 96"	96" / 108" 56	120" / 120" 80	95" / 120"
SheerWeave 2390	Max Width / Max Height Max Sq Ft	192** / 120"	103" / 96"	84" / 84"	96" / 96"	72" / 96"	96" / 108" 56	120" / 120" 80	95" / 120"
SheerWeave 2410	Max Width / Max Height Max Sq Ft	192** / 120"	103" / 96"	84" / 84"	96" / 96"	72" / 96"	96" / 108" 56	120" / 120" 80	95" / 120"
SheerWeave 2500	Max Width / Max Height Max Sq Ft	192** / 120"	103" / 96"	84" / 84"	96" / 96"	72" / 96"	96" / 96" 56	120" / 120" 72	95" / 120"
SheerWeave 3000	Max Width / Max Height Max Sq Ft	96" / 120"	96" / 96"	84" / 84"	96" / 96"	72" / 96"	96" / 78" 50	96" / 102" 68	87" / 120"
SheerWeave 4100	Max Width / Max Height Max Sq Ft	192** / 120"	103** / 96"	84" / 84"	N/A	N/A	96" / 72" 48	120** / 96" 72	95** / 120"
SheerWeave 4400	Max Width / Max Height Max Sq Ft	126" / 120"	103" / 96"	84" / 84"	96" / 96"	72" / 96"	96" / 66" 42	120" / 96" 68	95" / 120"
SheerWeave 5000	Max Width / Max Height Max Sq Ft	98" / 120"	98" / 96"	84" / 84"	96" / 96"	72" / 96"	96" / 54" 36	98" / 96" 64	95" / 120"
SheerWeave 7000	Max Width / Max Height Max Sq Ft	192** / 120"	103" / 96"	84" / 84"	96" / 96"	72" / 96"	96" / 78" 52	120** / 96" 80	95" / 120"
	Minimum Width	15"	15"	15"	30 1/2"	18 1/2"*	15"	15"	15"
	Minimum Height	24"	24"	24"	24"	24"	24"	24"	24"

* Railroading this fabric results in a larger maximum width than the fabric width.

♦ For widths 18 1/2" to 26 1/2", shades are available up to 56" long.

For shades greater than 120" window height a different tube size may be required. Contact Customer Service for shades over 120" window height.

Size Standards Window Shades

		SL & R Clutch Page 41	Luxe™ Clutch Page 42	Sure- Lift™ Page 50	EZ Pull™ Page 51	EZ Lift™ Page 52	Small Cassette Page 58	Large Cassette Page 58	Board Mounted Page 60
Sheerweave 7400	Max Width / Max Height Max Sq Ft	118" / 120"	103" / 96"	84" / 84"	96" / 96"	72" / 96"	96" / 78" 52	118" / 96" 80	95" / 120"
Sheerweave 7450	Max Width / Max Height Max Sq Ft	118" / 120"	103" / 96"	84" / 84"	96" / 96"	72" / 96"	96" / 96" 56	118" / 108" 80	95" / 120"
SheerWeave Infinity 2 3% or 5%	Max Width / Max Height Max Sq Ft	98" / 120"	98" / 96"	84" / 84"	96" / 96"	72" / 96"	96" / 72" 48	98" / 102" 68	89" / 120"
SheerWeave Perf+ 2390	Max Width / Max Height Max Sq Ft	96" / 120"	96" / 96"	84" / 84"	96" / 96"	72" / 96"	96" / 96" 48	96" / 108" 68	87" / 120"
SheerWeave Perf+ 2410	Max Width / Max Height Max Sq Ft	96" / 120"	96" / 96"	84" / 84"	96" / 96"	72" / 96"	96" / 96" 48	96" / 108" 68	87" / 120"
Solar Screen- 1% or 3%	Max Width / Max Height Max Sq Ft	118" / 120 "	103" / 96"	84" / 84"	96" / 96"	72" / 96"	96" / 84" 48	118" / 108" 64	95" / 120"
Spector	Max Width / Max Height Max Sq Ft	84" / 120"	84" / 96"	84" / 84"	84" / 96"	72" / 96"	84" / 96" 48	84" / 108" 60	75" / 120"
Spiral - Serged Edge	Max Width / Max Height Max Sq Ft	102" / 120"	102" / 96"	84" / 84"	96" / 96"	72" / 96"	96" / 72" 48	102" / 96" 60	93" / 120"
Strata	Max Width / Max Height Max Sq Ft	81" / 120"	81" / 96"	81" / 84"	81" / 96"	72" / 96"	81" / 96" 54	81" / 108" 60	72" / 120"
Strie - Serged Edge	Max Width / Max Height Max Sq Ft	72" / 120"	72" / 96"	72" / 84"	72" / 96"	72" / 96"	72" / 90" 42	72" / 102" 51	63" / 120"
SuperWide	Max Width / Max Height Max Sq Ft	192** / 120"	103" / 96"	84" / 84"	96" / 96"	72" / 96"	96" / 102" 56	120** / 120" 80	95" / 120"
T Screen KOOLBLACK 3%	Max Width / Max Height Max Sq Ft	122" / 120"	103" / 96"	84" / 84"	96" / 96"	72" / 96"	96" / 84" 56	120" / 120" 80	95" / 120"
T Screen KOOLBLACK 5%	Max Width / Max Height Max Sq Ft	122" / 120"	103" / 96"	84" / 84"	96" / 96"	72" / 96"	96" / 84" 56	120" / 108" 80	95" / 120"
Tahiti	Max Width / Max Height Max Sq Ft	70" / 120"	N/A	N/A	N/A	N/A	N/A	N/A	61" / 120"
Triad	Max Width / Max Height Max Sq Ft	118" / 120"	103" / 96"	84" / 84"	96" / 96"	72" / 96"	96" / 72" 48	118" / 96" 75	95" / 120"
Tussah	Max Width / Max Height Max Sq Ft	110" / 120"	103" / 96"	84" / 84"	96" / 96"	72" / 96"	96" / 96" 48	110" / 108" 72	95" / 120"
Valencia	Max Width / Max Height Max Sq Ft	94" / 120"	94" / 96"	84" / 84"	94" / 96"	72" / 96"	94" / 108" 56	94" / 120" 78	85" / 120"
Viking	Max Width / Max Height Max Sq Ft	120** / 120"	103** / 96"	84** / 84"	96** / 96"	72" / 96"	96** / 120" 56	120** / 120" 80	95** / 120"
Vision	Max Width / Max Height Max Sq Ft	118" / 120"	103" / 96"	84" / 84"	96" / 96"	72" / 96"	96" / 84" 48	118" / 96" 78	95" / 120"
Vista Screen	Max Width / Max Height Max Sq Ft	98" / 120"	98" / 96"	84" / 84"	96" / 96"	72" / 96"	96" / 96" 56	98" / 108" 72	89" / 120"
Vizela	Max Width / Max Height Max Sq Ft	94" / 120"	94" / 96"	84" / 84"	N/A	N/A	94" / 102" 56	94" / 120" 78	85" / 120"
Wave	Max Width / Max Height Max Sq Ft	72" / 120"	72" / 96"	72" / 84"	72" / 96"	72" / 96"	72" / 102" 51	72" / 120" 60	63" / 120"
Weave	Max Width / Max Height Max Sq Ft	72" / 120"	72" / 96"	72" / 84"	N/A	N/A	72" / 72" 39	72" / 102" 51	63" / 120"
Willow	Max Width / Max Height Max Sq Ft	72" / 120"	72" / 96"	72" / 84"	72" / 96"	72" / 96"	72" / 108" 54	72" / 120" 60	63" / 120"
Yellowstone	Max Width / Max Height Max Sq Ft	72" / 120"	72" / 96"	72" / 84"	72" / 96"	72" / 96"	72" / 66" 33	72" / 96" 48	63" / 120"
Zootime	Max Width / Max Height Max Sq Ft	86" / 120"	86" / 96"	84" / 84"	86" / 96"	72" / 96"	86" / 72" 42	86" / 96" 56	77" / 120"
	Minimum Width	15"	15"	15"	30 1/2"	18 1/2"♦	15"	15"	15"
	Minimum Height	24"	24"	24"	24"	24"	24"	24"	24"

* Railroading this fabric results in a larger maximum width than the fabric width.

♦ For widths 18 1/2" to 26 1/2", shades are available up to 56" long.

For shades greater than 120" window height a different tube size may be required. Contact Customer Service for shades over 120" window height.

Size Standards Window Shades

		3" Fascia Page 59	4" Fascia Page 59	5" Fascia Single Page 59	5" Fascia Dual Page 59	5" Pocket Single Page 59	5" Pocket Dual Page 59	Spring Roller Page 53	Top Down Page 54
Adele	Max Width / Max Height	98" / 96"	110" / 144"	110" / 168"	110" / 96"	110" / 168"	110" / 96"	110" / 96"	84" / 96"
Aedan	Max Width / Max Height	79" / 96"	79" / 144"	79" / 168"	79" / 96"	79" / 168"	79" / 96"	79" / 96"	79" / 96"
Beatty - Serged Edge	Max Width / Max Height	72" / 84"	72" / 144"	72" / 168"	72" / 96"	72" / 168"	72" / 96"	72" / 96"	72" / 96"
Berber Slub	Max Width / Max Height	72" / 96"	72" / 144"	72" / 168"	72" / 96"	72" / 168"	72" / 96"	72" / 96"	72" / 96"
Boho	Max Width / Max Height	94" / 96"	94" / 144"	94" / 168"	94" / 96"	94" / 168"	94" / 96"	94" / 96"	84" / 96"
Boucle	Max Width / Max Height	72" / 96"	72" / 144"	72" / 168"	72" / 96"	72" / 168"	72" / 96"	72" / 96"	72" / 96"
Brit	Max Width / Max Height	98" / 96"	98" / 144"	98" / 168"	98" / 96"	98" / 168"	98" / 96"	98" / 96"	84" / 96"
Cabos	Max Width / Max Height	98" / 96"	108" / 144"	108" / 168"	108" / 96"	108" / 168"	108" / 96"	108" / 96"	84" / 96"
Cayman	Max Width / Max Height	98" / 96"	110" / 144"	110" / 168"	110" / 96"	110" / 168"	110" / 96"	110" / 96"	84" / 96"
Charmed	Max Width / Max Height	98" / 96"	110" / 144"	110" / 168"	110" / 96"	110" / 168"	110" / 96"	N/A	N/A
Dakota	Max Width / Max Height Max Height	90" / 96"	90" / 144"	90" / 168"	90" / 96"	90" / 168"	90" / 96"	90" / 96"	84" / 96"
Dallas	Max Width / Max Height	72" / 96"	72" / 144"	72" / 144"	72" / 96"	72" / 168"	72" / 96"	72" / 96"	72" / 96"
Deco Screen	Max Width / Max Height	98" / 96"	98" / 144"	98" / 168"	98" / 96"	98" / 168"	98" / 96"	98" / 96"	84" / 96"
Dimensions 3%	Max Width / Max Height	98" / 96"	120" / 144"	120" / 168"	120" / 96"	120" / 168"	120" / 96"	120" / 96"	84" / 96"
Dimensions 5%	Max Width / Max Height	98" / 96"	120" / 144"	120" / 168"	120" / 96"	120" / 168"	120" / 96"	120" / 96"	84" / 96"
Duo Vue	Max Width / Max Height	98" / 96"	98" / 144"	98" / 168"	98" / 96"	98" / 168"	98" / 96"	98" / 96"	84" / 96"
E Screen 3% or 5%	Max Width / Max Height	98" / 96"	121" / 144"	122" / 168"	122" / 96"	122" / 168"	122" / 96"	122" / 96"	84" / 96"
E Screen with KOOLBLACK™ Technology 3% or 5%	Max Width / Max Height	98" / 96"	121" / 144"	122" / 168"	122" / 96"	122" / 168"	122" / 96"	122" / 96"	84" / 96"
Economy Screen	Max Width / Max Height	98" / 96"	118" / 144"	118" / 168"	118" / 96"	118" / 168"	118" / 96"	118" / 96"	84" / 96"
Fedora - Serged Edge	Max Width / Max Height	72" / 96"	72" / 144"	72" / 168"	72" / 96"	72" / 168"	72" / 96"	72" / 96"	72" / 96"
Fiber-Lucent	Max Width / Max Height	98** / 96"	120** / 144"	120** / 168"	120** / 96"	120** / 168"	120** / 96"	120** / 96"	84** / 96"
Flutter	Max Width / Max Height	96" / 96"	96" / 144"	96" / 168"	96" / 96"	96" / 168"	96" / 96"	N/A	N/A
Garbo	Max Width / Max Height	98" / 96"	110" / 144"	96" / 168"	96" / 96"	96" / 168"	96" / 96"	N/A	N/A
Grasscloth	Max Width / Max Height	72" / 96"	72" / 144"	72" / 168"	72" / 96"	72" / 168"	72" / 96"	72" / 96"	N/A
Harper	Max Width / Max Height	98" / 96"	115" / 144"	115" / 168"	115" / 96"	115" / 168"	115" / 96"	115" / 96"	84" / 96"
Highland	Max Width / Max Height	98" / 96"	118" / 144"	118" / 168"	118" / 96"	118" / 168"	118" / 96"	118" / 96"	84" / 96"
	Minimum Width	15"	15"	15"	15"	15"	15"	15"	24"
	Minimum Height	24"	24"	24"	24"	24"	24"	24"	24"

* Railroading this fabric results in a larger maximum width than the fabric width.

♦ For widths 18 1/2" to 26 1/2", shades are available up to 56" long.

For shades greater than 120" window height a different tube size may be required. Contact Customer Service for shades over 120" window height.

Size Standards Window Shades

		3" Fascia Page 59	4" Fascia Page 59	5" Fascia Single Page 59	5" Fascia Dual Page 59	5" Pocket Single Page 59	5" Pocket Dual Page 59	Spring Roller Page 53	Top Down Page 54
Hombre - Serged Edge	Max Width / Max Height	72" / 96"	72" / 144"	72" / 168"	72" / 96"	72" / 168"	72" / 96"	72" / 96"	72" / 96"
Homespun	Max Width / Max Height	79" / 96"	79" / 144"	79" / 168"	79" / 96"	79" / 168"	79" / 96"	79" / 96"	79" / 96"
Jackson	Max Width / Max Height	72" / 84"	72" / 144"	72" / 168"	72" / 96"	72" / 168"	72" / 96"	72" / 96"	72" / 96"
Katrina	Max Width / Max Height	98" / 96"	98" / 144"	98" / 168"	98" / 96"	98" / 168"	98" / 96"	98" / 96"	84" / 96"
Keilani	Max Width / Max Height	98" / 96"	108" / 144"	108" / 168"	108" / 96"	108" / 168"	108" / 96"	108" / 96"	84" / 96"
Kendo	Max Width / Max Height	94" / 96"	94" / 144"	94" / 168"	94" / 96"	94" / 168"	94" / 96"	94" / 96"	84" / 96"
Lexie	Max Width / Max Height	98" / 96"	110" / 144"	110" / 168"	110" / 96"	110" / 168"	110" / 96"	110" / 96"	84" / 96"
Light-Vue	Max Width / Max Height	98** / 96"	121** / 144"	192** / 168"	132** / 96"	192** / 168"	132** / 96"	N/A	N/A
Lindley - Serged Edge	Max Width / Max Height	72" / 96"	72" / 144"	72" / 168"	72" / 96"	72" / 168"	72" / 96"	72" / 96"	72" / 96"
Linen	Max Width / Max Height	78" / 96"	78" / 144"	78" / 168"	78" / 96"	78" / 168"	78" / 96"	78" / 96"	78" / 96"
Lizzy	Max Width / Max Height	86" / 96"	86" / 144"	86" / 168"	86" / 96"	86" / 168"	86" / 96"	86" / 96"	86" / 96"
Long Bay	Max Width / Max Height	98" / 96"	110" / 144"	110" / 168"	110" / 96"	110" / 168"	110" / 96"	110" / 96"	84" / 96"
Long Bay Blackout	Max Width / Max Height	98" / 96"	106" / 144"	106" / 168"	106" / 96"	106" / 168"	106" / 96"	106" / 96"	84" / 96"
Loretta	Max Width / Max Height	72" / 96"	72" / 144"	72" / 168"	72" / 96"	72" / 168"	72" / 96"	72" / 96"	72" / 96"
Lucinda	Max Width / Max Height	72" / 96"	72" / 144"	72" / 168"	72" / 96"	72" / 168"	72" / 96"	72" / 96"	72" / 96"
Luminescence	Max Width / Max Height	94" / 96"	94" / 144"	94" / 168"	94" / 96"	94" / 168"	94" / 96"	N/A	N/A
Lux Screen	Max Width / Max Height	98" / 96"	98" / 144"	98" / 168"	98" / 96"	98" / 168"	98" / 96"	98" / 96"	84" / 96"
Moire	Max Width / Max Height	72" / 96"	72" / 144"	72" / 168"	72" / 96"	72" / 108"	72" / 96"	72" / 96"	72" / 96"
Mystic	Max Width / Max Height	98" / 96"	108" / 144"	108" / 168"	108" / 96"	108" / 168"	108" / 96"	108" / 96"	84" / 96"
Mystic Eclipse	Max Width / Max Height	96" / 96"	110" / 144"	110" / 168"	110" / 96"	110" / 168"	110" / 96"	108" / 96"	84" / 96"
Net 3000	Max Width / Max Height	98" / 96"	121** / 144"	192** / 168"	132** / 96"	192** / 168"	132** / 96"	126** / 96"	84" / 96"
No-Lite Fiberglass - Duplex and Solids	Max Width / Max Height	98** / 96"	121** / 144"	192** / 168"	132** / 96"	192** / 168"	132** / 96"	126** / 96"	84** / 96"
Nordicscreen Plus BW - 3% or 5%	Max Width / Max Height	98" / 96"	118" / 144"	118" / 168"	118" / 96"	118" / 168"	118" / 96"	118" / 96"	84" / 96"
Nordicscreen Plus Twill - 1% or 3%	Max Width / Max Height	98" / 96"	118" / 144"	118" / 168"	118" / 96"	118" / 168"	118" / 96"	118" / 96"	84" / 96"
Opulence	Max Width / Max Height	98" / 84"	118" / 144"	118" / 168"	118" / 96"	118" / 168"	118" / 96"	118" / 96"	84" / 96"
Origami	Max Width / Max Height	98" / 96"	108" / 144"	108" / 168"	108" / 96"	108" / 168"	108" / 96"	108" / 96"	84" / 96"
Pacifica	Max Width / Max Height	98" / 84"	110" / 144"	110" / 168"	110" / 96"	110" / 168"	110" / 96"	110" / 96"	84" / 96"
	Minimum Width	15"	15"	15"	15"	15"	15"	15"	24"
	Minimum Height	24"	24"	24"	24"	24"	24"	24"	24"

* Railroading this fabric results in a larger maximum width than the fabric width.

♦ For widths 18 1/2" to 26 1/2", shades are available up to 56" long.

For shades greater than 120" window height a different tube size may be required. Contact Customer Service for shades over 120" window height.

Size Standards Window Shades

		3" Fascia Page 59	4" Fascia Page 59	5" Fascia Single Page 59	5" Fascia Dual Page 59	5" Pocket Single Page 59	5" Pocket Dual Page 59	Spring Roller Page 53	Top Down Page 54
Palm Beach	Max Width / Max Height	98" / 84"	118" / 144"	118" / 168"	118" / 96"	118" / 168"	118" / 96"	118" / 96"	84" / 96"
Pearlescent	Max Width / Max Height	98** / 96"	121** / 144"	192** / 168"	132** / 96"	192** / 168"	132** / 96"	126** / 96"	84** / 96"
Persia	Max Width / Max Height	98" / 96"	110" / 144"	110" / 168"	110" / 96"	110" / 168"	110" / 96"	110" / 96"	84" / 96"
Petticoat	Max Width / Max Height	98" / 84"	110" / 144"	110" / 168"	110" / 96"	110" / 168"	110" / 96"	110" / 96"	N/A
Princeton	Max Width / Max Height	78" / 96"	78" / 144"	78" / 168"	78" / 96"	78" / 168"	78" / 96"	78" / 96"	78" / 96"
Reserved	Max Width / Max Height	94" / 96"	94" / 144"	94" / 168"	94" / 96"	94" / 168"	94" / 96"	94" / 96"	N/A
Rocky Mountain - Serged Edge	Max Width / Max Height	70" / 96"	70" / 144"	70" / 168"	70" / 96"	70" / 168"	70" / 96"	70" / 96"	70" / 96"
Rollie - Serged Edge	Max Width / Max Height	98** / 96"	121** / 144"	192** / 168"	132** / 96"	192** / 168"	132** / 96"	126** / 96"	84** / 96"
S Screen Elements	Max Width / Max Height	98" / 84"	121" / 144"	122" / 168"	122" / 96"	122" / 168"	122" / 96"	122" / 96"	84" / 96"
S Screen Origins	Max Width / Max Height	98" / 84"	121" / 144"	122" / 168"	122" / 96"	122" / 168"	122" / 96"	122" / 96"	84" / 96"
Safari	Max Width / Max Height	72" / 96"	72" / 144"	72" / 168"	72" / 96"	72" / 168"	72" / 96"	72" / 96"	72" / 96"
Scala Blackout	Max Width / Max Height	98" / 96"	110" / 144"	110" / 168"	110" / 96"	110" / 168"	110" / 96"	110" / 96"	84" / 96"
Seclusion	Max Width / Max Height	98" / 96"	121** / 144"	192** / 168"	132** / 96"	192** / 168"	132** / 96"	126** / 96"	84" / 96"
Sedona	Max Width / Max Height	98" / 96"	110" / 144"	110" / 168"	110" / 96"	110" / 168"	110" / 96"	110" / 96"	84" / 96"
Serene	Max Width / Max Height	98" / 96"	98" / 144"	98" / 168"	98" / 96"	98" / 168"	98" / 96"	98" / 96"	84" / 96"
Seto 5000	Max Width / Max Height	98" / 96"	110" / 144"	110" / 168"	110" / 96"	110" / 168"	110" / 96"	110" / 96"	84" / 96"
Seto 6000	Max Width / Max Height	98" / 96"	110" / 144"	110" / 168"	110" / 96"	110" / 168"	110" / 96"	110" / 96"	84" / 96"
Shantung	Max Width / Max Height	79" / 96"	79" / 144"	79" / 168"	79" / 96"	79" / 168"	79" / 96"	79" / 96"	79" / 96"
SheerWeave 1000	Max Width / Max Height	96" / 96"	96" / 144"	96" / 168"	96" / 96"	96" / 168"	96" / 96"	96" / 96"	84" / 96"
SheerWeave 2000	Max Width / Max Height	98" / 96"	121" / 144"	192** / 168"	132** / 96"	192** / 168"	132** / 96"	126" / 96"	84" / 96"
SheerWeave 2390	Max Width / Max Height	98" / 96"	121" / 144"	192** / 168"	132** / 96"	192** / 168"	132** / 96"	126" / 96"	84" / 96"
SheerWeave 2410	Max Width / Max Height	98" / 96"	121" / 144"	192** / 168"	132** / 96"	192** / 168"	132** / 96"	126" / 96"	84" / 96"
SheerWeave 2500	Max Width / Max Height	98" / 96"	121" / 144"	192** / 168"	132** / 96"	192** / 168"	132** / 96"	126" / 96"	84" / 96"
SheerWeave 3000	Max Width / Max Height	96" / 96"	96" / 144"	96" / 168"	96" / 96"	96" / 168"	96" / 96"	96" / 96"	84" / 96"
SheerWeave 4100	Max Width / Max Height	98" / 96"	121** / 144"	192** / 168"	132** / 96"	192** / 168"	132** / 96"	126** / 96"	84" / 96"
SheerWeave 4400	Max Width / Max Height	98" / 84"	121" / 144"	126" / 168"	126" / 96"	126" / 168"	126" / 96"	126" / 96"	84" / 96"
SheerWeave 5000	Max Width / Max Height	98" / 84"	98" / 144"	98" / 168"	98" / 96"	98" / 168"	98" / 96"	98" / 96"	84" / 96"
SheerWeave 7000	Max Width / Max Height	98" / 96"	121** / 144"	192** / 168"	132** / 96"	192** / 168"	132** / 96"	126** / 96"	84" / 96"
	Minimum Width	15"	15"	15"	15"	15"	15"	15"	24"
	Minimum Height	24"	24"	24"	24"	24"	24"	24"	24"

* Railroading this fabric results in a larger maximum width than the fabric width.

♦ For widths 18 1/2" to 26 1/2", shades are available up to 56" long.

For shades greater than 120" window height a different tube size may be required. Contact Customer Service for shades over 120" window height.

Size Standards Window Shades

		3" Fascia Page 59	4" Fascia Page 59	5" Fascia Single Page 59	5" Fascia Dual Page 59	5" Pocket Single Page 59	5" Pocket Dual Page 59	Spring Roller Page 53	Top Down Page 54
Sheerweave 7400	Max Width / Max Height	98" / 96"	118" / 144"	118" / 168"	118" / 96"	118" / 168"	118" / 96"	118" / 96"	84" / 96"
Sheerweave 7450	Max Width / Max Height	98" / 96"	118" / 144"	118" / 168"	118" / 96"	118" / 168"	118" / 96"	118" / 96"	84" / 96"
SheerWeave Infinity 2 3% or 5%	Max Width / Max Height	98" / 84"	98" / 144"	98" / 168"	98" / 96"	98" / 168"	98" / 96"	98" / 96"	84" / 96"
SheerWeave Perf+ 2390	Max Width / Max Height	96" / 96"	96" / 144"	96" / 168"	96" / 96"	96" / 168"	96" / 96"	96" / 96"	84" / 96"
SheerWeave Perf+ 2410	Max Width / Max Height	96" / 96"	96" / 144"	96" / 168"	96" / 96"	96" / 168"	96" / 96"	96" / 96"	84" / 96"
Solar Screen 1% or 3%	Max Width / Max Height	98" / 96"	118" / 144"	118" / 168"	118" / 96"	118" / 168"	118" / 96"	118" / 96"	84" / 96"
Spector	Max Width / Max Height	84" / 96"	84" / 144"	84" / 168"	84" / 96"	84" / 168"	84" / 96"	84" / 96"	84" / 96"
Spiral - Serged Edge	Max Width / Max Height	98" / 96"	102" / 144"	102" / 168"	102" / 96"	102" / 168"	102" / 96"	102" / 96"	84" / 96"
Strata	Max Width / Max Height	81" / 96"	81" / 144"	81" / 168"	81" / 96"	81" / 168"	81" / 96"	81" / 96"	81" / 96"
Strie - Serged Edge	Max Width / Max Height	72" / 96"	72" / 144"	72" / 168"	72" / 96"	72" / 168"	72" / 96"	72" / 96"	72" / 96"
SuperWide	Max Width / Max Height	98" / 96"	121** / 144"	192** / 168"	132** / 96"	192** / 168"	132** / 96"	126** / 96"	84" / 96"
T Screen KOOLBLACK 3%	Max Width / Max Height	98" / 96"	121" / 144"	122" / 168"	122" / 96"	122" / 168"	122" / 96"	122" / 96"	84" / 96"
T Screen KOOLBLACK 5%	Max Width / Max Height	98" / 96"	121" / 144"	122" / 168"	122" / 96"	122" / 168"	122" / 96"	122" / 96"	84" / 96"
Tahiti	Max Width / Max Height	N/A	N/A	N/A	N/A	N/A	N/A	NA	70" / 96"
Triad	Max Width / Max Height	98" / 96"	118" / 144"	118" / 168"	118" / 96"	118" / 168"	118" / 96"	118" / 96"	84" / 96"
Tussah	Max Width / Max Height	98" / 84"	110" / 144"	110" / 168"	110" / 96"	110" / 168"	110" / 96"	110" / 96"	84" / 96"
Valencia	Max Width / Max Height	94" / 96"	94" / 144"	94" / 168"	94" / 96"	94" / 168"	94" / 96"	94" / 96"	84" / 96"
Viking	Max Width / Max Height	98** / 96"	120** / 144"	120** / 168"	120** / 96"	120** / 168"	120** / 96"	120** / 96"	84** / 96"
Vision	Max Width / Max Height	98" / 96"	118" / 144"	118" / 168"	118" / 96"	118" / 168"	118" / 96"	118" / 96"	84" / 96"
Vista Screen	Max Width / Max Height	98" / 96"	98" / 144"	98" / 168"	98" / 96"	98" / 168"	98" / 96"	98" / 96"	84" / 96"
Vizela	Max Width / Max Height	94" / 96"	94" / 144"	94" / 168"	94" / 96"	94" / 168"	94" / 96"	94" / 96"	84" / 96"
Wave	Max Width / Max Height	72" / 96"	72" / 144"	72" / 168"	72" / 96"	72" / 168"	72" / 96"	72" / 96"	72" / 96"
Weave	Max Width / Max Height	72" / 84"	72" / 144"	72" / 168"	72" / 96"	72" / 168"	72" / 96"	72" / 96"	72" / 96"
Willow	Max Width / Max Height	72" / 96"	72" / 144"	72" / 168"	72" / 96"	72" / 168"	72" / 96"	72" / 96"	72" / 96"
Yellowstone	Max Width / Max Height	72" / 96"	72" / 144"	72" / 168"	72" / 96"	72" / 168"	72" / 96"	72" / 96"	72" / 96"
Zootime	Max Width / Max Height	86" / 96"	86" / 144"	86" / 168"	86" / 96"	86" / 168"	86" / 96"	86" / 96"	84" / 96"
	Minimum Width	15"	15"	15"	15"	15"	15"	15"	24"
	Minimum Height	24"	24"	24"	24"	24"	24"	24"	24"

* Railroading this fabric results in a larger maximum width than the fabric width.

♦ For widths 18 1/2" to 26 1/2", shades are available up to 56" long.

For shades greater than 120" window height a different tube size may be required. Contact Customer Service for shades over 120" window height.

Motorized Shades - Size Standards Window Shades

		Somfy System II Battery Pages 44-45	Somfy Sonesse® 30 Wirefree Pages 44-45	EZ Charge Rechargeable V 2.0 Pages 46-47	EZ Charge Rechargeable X2 Pages 46-47	EZ Charge Rechargeable X3 Pages 46-47	Auto-Wand Motor Page 43
Adele	Max Width / Max Height	102" / 120"	110" / 120"	96" / 120"	110" / 120"	110" / 144"	96" / 96"
	Max Area (sq ft.)	64	80	64	80	144	64
Aedan	Max Width / Max Height	79" / 120"	79" / 120"	79" / 120"	79" / 120"	79" / 144"	79" / 96"
	Max Area (sq ft.)	64	80	64	80	144	64
Beatty - Serged Edge	Max Width / Max Height	72" / 120"	72" / 120"	72" / 120"	72" / 120"	72" / 144"	72" / 96"
	Max Area (sq ft.)	64	80	64	80	144	64
Berber Slub	Max Width / Max Height	72" / 120"	72" / 120"	72" / 120"	72" / 120"	72" / 144"	72" / 96"
	Max Area (sq ft.)	64	80	64	80	144	64
Boho	Max Width / Max Height	94" / 120"	94" / 120"	94" / 120"	94" / 120"	94" / 144"	94" / 96"
	Max Area (sq ft.)	64	80	64	80	144	64
Boucle	Max Width / Max Height	72" / 120"	72" / 120"	72" / 120"	72" / 120"	72" / 144"	72" / 96"
	Max Area (sq ft.)	64	80	64	80	144	64
Brit	Max Width / Max Height	98" / 120"	98" / 120"	96" / 120"	98" / 120"	98" / 144"	96" / 96"
	Max Area (sq ft.)	64	80	64	80	144	64
Cabos	Max Width / Max Height	102" / 120"	108" / 120"	96" / 120"	108" / 120"	108" / 144"	96" / 96"
	Max Area (sq ft.)	64	80	64	80	144	64
Cayman	Max Width / Max Height	102" / 120"	110" / 120"	96" / 120"	110" / 120"	110" / 144"	96" / 96"
	Max Area (sq ft.)	64	80	64	80	144	64
Charmed	Max Width / Max Height	102" / 120"	110" / 120"	96" / 120"	110" / 120"	110" / 144"	96" / 96"
	Max Area (sq ft.)	64	80	64	80	144	64
Dakota	Max Width / Max Height	90" / 120"	90" / 120"	90" / 120"	90" / 120"	90" / 144"	90" / 96"
	Max Area (sq ft.)	64	80	64	80	144	64
Dallas	Max Width / Max Height	72" / 120"	72" / 120"	72" / 120"	72" / 120"	72" / 144"	72" / 96"
	Max Area (sq ft.)	64	80	64	80	144	64
Deco Screen	Max Width / Max Height	98" / 120"	98" / 120"	96" / 120"	98" / 120"	98" / 144"	96" / 96"
	Max Area (sq ft.)	64	80	64	80	144	64
Dimensions 3% or 5%	Max Width / Max Height	102" / 120"	120" / 120"	96" / 120"	120" / 120"	120" / 144"	96" / 96"
	Max Area (sq ft.)	64	80	64	80	144	64
Duo Vue	Max Width / Max Height	98" / 120"	98" / 120"	96" / 120"	98" / 120"	98" / 144"	96" / 96"
	Max Area (sq ft.)	64	80	64	80	144	64
E Screen 3% or 5%	Max Width / Max Height	102" / 120"	120" / 120"	96" / 120"	120" / 120"	122" / 144"	96" / 96"
	Max Area (sq ft.)	64	80	64	80	144	64
E Screen w/ KOOLBLACK™ Technology 3% or 5%	Max Width / Max Height	102" / 120"	120" / 120"	96" / 120"	120" / 120"	122" / 144"	96" / 96"
	Max Area (sq ft.)	64	80	64	80	144	64
Economy Screen	Max Width / Max Height	N/A	N/A	N/A	N/A	N/A	N/A
	Max Area (sq ft.)						
Fedora - Serged Edge	Max Width / Max Height	72" / 120"	72" / 120"	72" / 120"	72" / 120"	72" / 144"	72" / 96"
	Max Area (sq ft.)	64	80	64	80	144	64
Fiber-Lucent	Max Width / Max Height	102** / 120"	120** / 120"	96** / 120"	120** / 120"	120** / 144"	96** / 96"
	Max Area (sq ft.)	64	80	64	80	144	64
Flutter	Max Width / Max Height	96" / 120"	96" / 120"	96" / 120"	96" / 120"	96" / 144"	96" / 96"
	Max Area (sq ft.)	64	80	64	80	144	64
Garbo	Max Width / Max Height	102" / 120"	110" / 120"	96" / 120"	110" / 120"	110" / 144"	96" / 96"
	Max Area (sq ft.)	64	80	64	80	144	64
Grasscloth	Max Width / Max Height	72" / 120"	72" / 120"	72" / 120"	72" / 120"	72" / 144"	72" / 96"
	Max Area (sq ft.)	64	80	64	80	144	64
Harper	Max Width / Max Height	102" / 120"	115" / 120"	96" / 120"	115" / 120"	115" / 144"	96" / 96"
	Max Area (sq ft.)	64	80	64	80	144	64
Highland	Max Width / Max Height	102" / 120"	118" / 120"	96" / 120"	118" / 120"	118" / 144"	96" / 96"
	Max Area (sq ft.)	64	80	64	80	144	64
	Minimum Width	16"	29"	22"	32"	42"	22"
	Minimum Height	24"	24"	24"	24"	24"	28"

* Railroading this fabric results in a larger maximum width than the fabric width.

Motorized Shades - Size Standards Window Shades

		Somfy System II Battery Pages 44-45	Somfy Sonesse® 30 Wirefree Pages 44-45	EZ Charge Rechargeable V 2.0 Pages 46-47	EZ Charge Rechargeable X2 Pages 46-47	EZ Charge Rechargeable X3 Pages 46-47	Auto-Wand Motor Page 43
Hombre - Serged Edge	Max Width / Max Height	72" / 120"	72" / 120"	72" / 120"	72" / 120"	72" / 144"	72" / 96"
	Max Area (sq ft.)	64	80	64	80	144	64
Homespun	Max Width / Max Height	79" / 120"	79" / 120"	79" / 120"	79" / 120"	79" / 144"	79" / 96"
	Max Area (sq ft.)	64	80	64	80	144	64
Jackson	Max Width / Max Height	72" / 120"	72" / 120"	72" / 120"	72" / 120"	72" / 144"	72" / 96"
	Max Area (sq ft.)	64	80	64	80	144	64
Katrina	Max Width / Max Height	98" / 120"	98" / 120"	96" / 120"	98" / 120"	98" / 144"	96" / 96"
	Max Area (sq ft.)	64	80	64	80	144	64
Keilani	Max Width / Max Height	102" / 120"	108" / 120"	96" / 120"	108" / 120"	108" / 144"	96" / 96"
	Max Area (sq ft.)	64	80	64	80	144	64
Kendo	Max Width / Max Height	94" / 120"	94" / 120"	94" / 120"	94" / 120"	94" / 144"	94" / 96"
	Max Area (sq ft.)	64	80	64	80	144	64
Lexie	Max Width / Max Height	102" / 120"	110" / 120"	96" / 120"	110" / 120"	110" / 144"	96" / 96"
	Max Area (sq ft.)	64	80	64	80	144	64
Light-Vue	Max Width / Max Height	102** / 120"	120** / 120"	96** / 120"	120** / 120"	144** / 144"	96** / 96"
	Max Area (sq ft.)	64	80	64	80	144	64
Lindley- Serged Edge	Max Width / Max Height	72" / 120"	72" / 120"	72" / 120"	72" / 120"	72" / 144"	72" / 96"
	Max Area (sq ft.)	64	80	64	80	144	64
Linen	Max Width / Max Height	78" / 120"	78" / 120"	78" / 120"	78" / 120"	78" / 144"	78" / 96"
	Max Area (sq ft.)	64	80	64	80	144	64
Lizzy	Max Width / Max Height	86" / 120"	86" / 120"	86" / 120"	86" / 120"	86" / 144"	86" / 96"
	Max Area (sq ft.)	64	80	64	80	144	64
Long Bay	Max Width / Max Height	102" / 120"	110" / 120"	96" / 120"	110" / 120"	110" / 144"	96" / 96"
	Max Area (sq ft.)	64	80	64	80	144	64
Long Bay Blackout	Max Width / Max Height	102" / 120"	106" / 120"	96" / 120"	106" / 120"	106" / 144"	96" / 96"
	Max Area (sq ft.)	64	80	64	80	144	64
Loretta	Max Width / Max Height	72" / 120"	72" / 120"	72" / 120"	72" / 120"	72" / 144"	72" / 96"
	Max Area (sq ft.)	64	80	64	80	144	64
Lucinda	Max Width / Max Height	72" / 120"	72" / 120"	72" / 120"	72" / 120"	72" / 144"	72" / 96"
	Max Area (sq ft.)	64	80	64	80	144	64
Luminescence	Max Width / Max Height	94" / 120"	94" / 120"	94" / 120"	94" / 120"	94" / 144"	94" / 96"
	Max Area (sq ft.)	64	80	64	80	144	64
Lux Screen	Max Width / Max Height	98" / 120"	98" / 120"	96" / 120"	98" / 120"	98" / 144"	96" / 96"
	Max Area (sq ft.)	64	80	64	80	144	64
Moire	Max Width / Max Height	72" / 120"	72" / 120"	72" / 120"	72" / 120"	72" / 144"	72" / 96"
	Max Area (sq ft.)	64	80	64	80	144	64
Mystic	Max Width / Max Height	102" / 120"	108" / 120"	96" / 120"	108" / 120"	108" / 144"	96" / 96"
	Max Area (sq ft.)	64	80	64	80	144	64
Mystic Eclipse	Max Width / Max Height	102" / 120"	110" / 120"	96" / 120"	110" / 120"	110" / 144"	96" / 96"
	Max Area (sq ft.)	64	80	64	80	144	64
Net 3000	Max Width / Max Height	102" / 120"	120** / 120"	96" / 120"	120** / 120"	144** / 144"	96" / 96"
	Max Area (sq ft.)	64	80	64	80	144	64
No-Lite Fiberglass - Duplex and Solids	Max Width / Max Height	102** / 120"	120** / 120"	96** / 120"	120** / 120"	144** / 144"	96** / 96"
	Max Area (sq ft.)	64	80	64	80	144	64
Nordicscreen Plus BW (3% and 5%) or Twill (1% or 3%)	Max Width / Max Height	102" / 120"	118" / 120"	96" / 120"	118" / 120"	118" / 144"	96" / 96"
	Max Area (sq ft.)	64	80	64	80	144	64
Opulence	Max Width / Max Height	102" / 120"	118" / 120"	96" / 120"	118" / 120"	118" / 144"	96" / 96"
	Max Area (sq ft.)	64	80	64	80	144	64
Origami	Max Width / Max Height	102" / 120"	108" / 120"	96" / 120"	108" / 120"	108" / 144"	96" / 96"
	Max Area (sq ft.)	64	80	64	80	144	64
Pacifica	Max Width / Max Height	102" / 120"	110" / 120"	96" / 120"	110" / 120"	110" / 144"	96" / 96"
	Max Area (sq ft.)	64	80	64	80	144	64
Palm Beach	Max Width / Max Height	102" / 120"	118" / 120"	96" / 120"	118" / 120"	118" / 144"	96" / 96"
	Max Area (sq ft.)	64	80	64	80	144	64
	Minimum Width	16"	29"	22"	32"	42"	22"
	Minimum Height	24"	24"	24"	24"	24"	28"

* Railroading this fabric results in a larger maximum width than the fabric width.

Motorized Shades - Size Standards Window Shades

		Somfy System II Battery Pages 44-45	Somfy Sonesse® 30 Wirefree Pages 44-45	EZ Charge Rechargeable V 2.0 Pages 46-47	EZ Charge Rechargeable X2 Pages 46-47	EZ Charge Rechargeable X3 Pages 46-47	Auto-Wand Motor Page 43
Pearlescent	Max Width / Max Height	102** / 120"	120** / 120"	96** / 120"	120** / 120"	144** / 144"	96** / 96"
	Max Area (sq ft.)	64	80	64	80	144	64
Persia	Max Width / Max Height	102" / 120"	110" / 120"	96" / 120"	110" / 120"	110" / 144"	96" / 96"
	Max Area (sq ft.)	64	80	64	80	144	64
Petticoat	Max Width / Max Height	102" / 120"	110" / 120"	96" / 120"	110" / 120"	110" / 144"	96" / 96"
	Max Area (sq ft.)	64	80	64	80	144	64
Princeton	Max Width / Max Height	78" / 120"	78" / 120"	78" / 120"	78" / 120"	78" / 144"	78" / 96"
	Max Area (sq ft.)	64	80	64	80	144	64
Reserved	Max Width / Max Height	94" / 120"	94" / 120"	94" / 120"	94" / 120"	94" / 144"	94" / 96"
	Max Area (sq ft.)	64	80	64	80	144	64
Rocky Mountain - Serged Edge	Max Width / Max Height	70" / 120"	70" / 120"	70" / 120"	70" / 120"	70" / 144"	70" / 96"
	Max Area (sq ft.)	64	80	64	80	144	64
Rollie - Serged Edge	Max Width / Max Height	102** / 120"	120** / 120"	96** / 120"	120** / 120"	144** / 144"	96** / 96"
	Max Area (sq ft.)	64	80	64	80	144	64
S Screen Elements	Max Width / Max Height	102" / 120"	120" / 120"	96" / 120"	120" / 120"	122" / 144"	96" / 96"
	Max Area (sq ft.)	64	80	64	80	144	64
S Screen Origins	Max Width / Max Height	102" / 120"	120" / 120"	96" / 120"	120" / 120"	122" / 144"	96" / 96"
	Max Area (sq ft.)	64	80	64	80	144	64
Safari	Max Width / Max Height	72" / 120"	72" / 120"	72" / 120"	72" / 120"	72" / 144"	72" / 96"
	Max Area (sq ft.)	64	80	64	80	144	64
Scala Blackout	Max Width / Max Height	102" / 120"	110" / 120"	96" / 120"	110" / 120"	110" / 144"	96" / 96"
	Max Area (sq ft.)	64	80	64	80	144	64
Seclusion	Max Width / Max Height	102" / 120"	120" / 120"	96" / 120"	120" / 120"	144** / 144"	96" / 96"
	Max Area (sq ft.)	64	80	64	80	144	64
Sedona	Max Width / Max Height	102" / 120"	110" / 120"	96" / 120"	110" / 120"	110" / 144"	96" / 96"
	Max Area (sq ft.)	64	80	64	80	144	64
Serene	Max Width / Max Height	98" / 120"	98" / 120"	96" / 120"	98" / 120"	98" / 144"	96" / 96"
	Max Area (sq ft.)	64	80	64	80	144	64
Seto 5000	Max Width / Max Height	102" / 120"	110" / 120"	96" / 120"	110" / 120"	110" / 144"	96" / 96"
	Max Area (sq ft.)	64	80	64	80	144	64
Seto 6000	Max Width / Max Height	102" / 120"	110" / 120"	96" / 120"	110" / 120"	110" / 144"	96" / 96"
	Max Area (sq ft.)	64	80	64	80	144	64
Shantung	Max Width / Max Height	79" / 120"	79" / 120"	79" / 120"	79" / 120"	79" / 144"	79" / 96"
	Max Area (sq ft.)	64	80	64	80	144	64
SheerWeave 1000	Max Width / Max Height	96" / 120"	96" / 120"	96" / 120"	96" / 120"	96" / 144"	96" / 96"
	Max Area (sq ft.)	64	80	64	80	144	64
SheerWeave 2000	Max Width / Max Height	102" / 120"	120" / 120"	96" / 120"	120" / 120"	144** / 144"	96" / 96"
	Max Area (sq ft.)	64	80	64	80	144	64
SheerWeave 2390	Max Width / Max Height	102" / 120"	120" / 120"	96" / 120"	120" / 120"	144** / 144"	96" / 96"
	Max Area (sq ft.)	64	80	64	80	144	64
SheerWeave 2410	Max Width / Max Height	102" / 120"	120" / 120"	96" / 120"	120" / 120"	144** / 144"	96" / 96"
	Max Area (sq ft.)	64	80	64	80	144	64
SheerWeave 2500	Max Width / Max Height	102" / 120"	120" / 120"	96" / 120"	120" / 120"	144** / 144"	96" / 96"
	Max Area (sq ft.)	64	80	64	80	144	64
SheerWeave 3000	Max Width / Max Height	96" / 120"	96" / 120"	96" / 120"	96" / 120"	96" / 144"	96" / 96"
	Max Area (sq ft.)	64	80	64	80	144	64
SheerWeave 4100	Max Width / Max Height	102** / 120"	120** / 120"	96" / 120"	120** / 120"	144** / 144"	96" / 96"
	Max Area (sq ft.)	64	80	64	80	144	64
SheerWeave 4400	Max Width / Max Height	102" / 120"	120" / 120"	96" / 120"	120" / 120"	126" / 144"	96" / 96"
	Max Area (sq ft.)	64	80	64	80	144	64
SheerWeave 5000	Max Width / Max Height	98" / 120"	98" / 120"	96" / 120"	98" / 120"	98" / 144"	96" / 96"
	Max Area (sq ft.)	64	80	64	80	144	64
SheerWeave 7000	Max Width / Max Height	102" / 120"	120** / 120"	96" / 120"	120** / 120"	144** / 144"	96" / 96"
	Max Area (sq ft.)	64	80	64	80	144	64
Sheerweave 7400	Max Width / Max Height	102" / 120"	118" / 120"	96" / 120"	118" / 120"	118" / 144"	96" / 96"
	Max Area (sq ft.)	64	80	64	80	144	64
	Minimum Width	16"	29"	22"	32"	42"	22"
	Minimum Height	24"	24"	24"	24"	24"	28"

* Railroading this fabric results in a larger maximum width than the fabric width.

Motorized Shades - Size Standards Window Shades

		Somfy System II Battery Pages 44-45	Somfy Sonesse® 30 Wirefree Pages 44-45	EZ Charge Rechargeable V 2.0 Pages 46-47	EZ Charge Rechargeable X2 Pages 46-47	EZ Charge Rechargeable X3 Pages 46-47	Auto-Wand Motor Page 43
Sheerweave 7450	Max Width / Max Height	102" / 120"	118" / 120"	96" / 120"	118" / 120"	118" / 144"	96" / 96"
	Max Area (sq ft.)	64	80	64	80	144	64
SheerWeave Infinity 2 3% or 5%	Max Width / Max Height	98" / 120"	98" / 120"	96" / 120"	98" / 120"	98" / 144"	96" / 96"
	Max Area (sq ft.)	64	80	64	80	144	64
SheerWeave Perf+ 2390	Max Width / Max Height	96" / 120"	96" / 120"	96" / 120"	96" / 120"	96" / 144"	96" / 96"
	Max Area (sq ft.)	64	80	64	80	144	64
SheerWeave Perf+ 2410	Max Width / Max Height	96" / 120"	96" / 120"	96" / 120"	96" / 120"	96" / 144"	96" / 96"
	Max Area (sq ft.)	64	80	64	80	144	64
Solar Screen 3000 1% or 3%	Max Width / Max Height	102" / 120"	118" / 120"	96" / 120"	118" / 120"	118" / 144"	96" / 96"
	Max Area (sq ft.)	64	80	64	80	144	64
Spector	Max Width / Max Height	84" / 120"	84" / 120"	84" / 120"	84" / 120"	84" / 144"	84" / 96"
	Max Area (sq ft.)	64	80	64	80	144	64
Spiral- Serged Edge	Max Width / Max Height	102" / 120"	102" / 120"	96" / 120"	102" / 120"	102" / 144"	96" / 96"
	Max Area (sq ft.)	64	80	64	80	144	64
Strata	Max Width / Max Height	81" / 120"	81" / 120"	81" / 120"	81" / 120"	81" / 144"	81" / 96"
	Max Area (sq ft.)	64	80	64	80	144	64
Strie- Serged Edge	Max Width / Max Height	72" / 120"	72" / 120"	72" / 120"	72" / 120"	72" / 144"	72" / 96"
	Max Area (sq ft.)	64	80	64	80	144	64
SuperWide	Max Width / Max Height	102" / 120"	120** / 120"	96" / 120"	120** / 120"	144** / 144"	96" / 96"
	Max Area (sq ft.)	64	80	64	80	144	64
T Screen with KOOLBLACK Technology 3% or 5%	Max Width / Max Height	102" / 120"	120" / 120"	96" / 120"	120" / 120"	122" / 144"	96" / 96"
	Max Area (sq ft.)	64	80	64	80	144	64
Tahiti	Max Width / Max Height	70" / 120"	70" / 120"	70" / 120"	70" / 120"	70" / 144"	70" / 96"
	Max Area (sq ft.)	64	80	64	80	144	64
Triad	Max Width / Max Height	102" / 120"	118" / 120"	96" / 120"	118" / 120"	118" / 144"	96" / 96"
	Max Area (sq ft.)	64	80	64	80	144	64
Tussah	Max Width / Max Height	102" / 120"	110" / 120"	96" / 120"	110" / 120"	110" / 144"	96" / 96"
	Max Area (sq ft.)	64	80	64	80	144	64
Valencia	Max Width / Max Height	94" / 120"	94" / 120"	94" / 120"	94" / 120"	94" / 144"	94" / 96"
	Max Area (sq ft.)	64	80	64	80	144	64
Viking	Max Width / Max Height	102** / 120"	120** / 120"	96** / 120"	120** / 120"	120** / 144"	96** / 96"
	Max Area (sq ft.)	94	80	64	80	144	64
Vision	Max Width / Max Height	102" / 120"	118" / 120"	96" / 120"	118" / 120"	118" / 144"	96" / 96"
	Max Area (sq ft.)	94	80	64	80	144	64
Vista Screen	Max Width / Max Height	98" / 120"	98" / 120"	96" / 120"	98" / 120"	98" / 144"	96" / 96"
	Max Area (sq ft.)	64	80	64	80	144	64
Vizela	Max Width / Max Height	94" / 120"	94" / 120"	94" / 120"	94" / 120"	94" / 144"	94" / 96"
	Max Area (sq ft.)	64	80	64	80	144	64
Wave	Max Width / Max Height	72" / 120"	72" / 120"	72" / 120"	72" / 120"	72" / 144"	72" / 96"
	Max Area (sq ft.)	64	80	64	80	144	64
Weave	Max Width / Max Height	72" / 120"	72" / 120"	72" / 120"	72" / 120"	72" / 144"	72" / 96"
	Max Area (sq ft.)	64	80	64	80	144	64
Willow	Max Width / Max Height	72" / 120"	72" / 120"	72" / 120"	72" / 120"	72" / 144"	72" / 96"
	Max Area (sq ft.)	64	80	64	80	144	64
Yellowstone	Max Width / Max Height	72" / 120"	72" / 120"	72" / 120"	72" / 120"	72" / 144"	72" / 96"
	Max Area (sq ft.)	64	80	64	80	144	64
Zootime	Max Width / Max Height	86" / 120"	86" / 120"	86" / 120"	86" / 120"	86" / 144"	86" / 96"
	Max Area (sq ft.)	64	80	64	80	144	64
	Minimum Width	16"	29"	22"	32"	42"	22"
	Minimum Height	24"	24"	24"	24"	24"	28"

* Railroading this fabric results in a larger maximum width than the fabric width.

Motorized Shades - Size Standards Window Shades

	Q Motion Size Fascia Option	2.6 Q Motion With Fascia or Without Fascia	3.3 QMotion With Fascia or Without Fascia	3.3 QMotion With Fascia or Without Fascia	4.3 QMotion With Fascia Only	4.3 QMotion With Fascia Only	4.3 QMotion With Fascia Only
	Shade Width	15 1/2" - 96"	15 1/2" - 96"	96"-118"	15 1/2" - 96"	96" - 118"	118" - 144"
Adele	Max Width / Max Height	96" / 80"	96" / 144"	110" / 144"	96" / 144"	110" / 144"	N/A
Aedan	Max Width / Max Height	79" / 120"	79" / 144"	N/A	79" / 144"	N/A	N/A
Beatty - Serged Edge	Max Width / Max Height	72" / 40"	72" / 110"	N/A	72" / 144"	N/A	N/A
Berber Slub	Max Width / Max Height	72" / 75"	72" / 144"	N/A	72" / 144"	N/A	N/A
Boho	Max Width / Max Height	94" / 120"	94" / 144"	N/A	94" / 144"	N/A	N/A
Boucle	Max Width / Max Height	72" / 144"	72" / 144"	N/A	72" / 144"	N/A	N/A
Brit	Max Width / Max Height	96" / 70"	96" / 144"	98" / 120"	96" / 144"	98" / 144"	N/A
Cabos	Max Width / Max Height	96" / 70"	96" / 144"	108" / 120"	96" / 144"	108" / 144"	N/A
Cayman	Max Width / Max Height	96" / 50"	96" / 144"	110" / 90"	96" / 144"	110" / 144"	N/A
Charmed	Max Width / Max Height	96" / 110"	96" / 144"	110" / 144"	96" / 144"	110" / 144"	N/A
Dakota	Max Width / Max Height	90" / 90"	90" / 144"	N/A	90" / 144"	N/A	N/A
Dallas	Max Width / Max Height	72" / 75"	72" / 144"	N/A	72" / 144"	N/A	N/A
Deco Screen	Max Width / Max Height	96" / 90"	96" / 144"	98" / 144"	96" / 144"	98" / 144"	N/A
Dimensions 3% or 5%	Max Width / Max Height	96" / 80"	96" / 144"	118" / 144"	96" / 144"	118" / 144"	120" / 144"
Duo Vue	Max Width / Max Height	96" / 70"	96" / 144"	98" / 144"	96" / 144"	98" / 144"	N/A
E Screen 3% or 5%	Max Width / Max Height	96" / 90"	96" / 144"	118" / 144"	96" / 144"	118" / 144"	122" / 144"
E Screen w/ KOOLBLACK™ Technology 3% or 5%	Max Width / Max Height	96" / 90"	96" / 144"	118" / 144"	96" / 144"	118" / 144"	122" / 144"
Economy Screen	Max Width / Max Height	N/A	N/A	N/A	N/A	N/A	N/A
Fedora - Serged Edge	Max Width / Max Height	72" / 90"	72" / 144"	N/A	72" / 144"	N/A	N/A
Fiber-Lucent	Max Width / Max Height	96** / 144"	96** / 144"	118** / 144"	96** / 144"	118** / 144"	120** / 144"
Flutter	Max Width / Max Height	96" / 110"	96" / 144"	N/A	96" / 144"	N/A	N/A
Garbo	Max Width / Max Height	96" / 110"	96" / 144"	110" / 144"	96" / 144"	110" / 144"	N/A
Grasscloth	Max Width / Max Height	72" / 75"	72" / 144"	N/A	72" / 144"	N/A	N/A
Harper	Max Width / Max Height	96" / 144"	96" / 144"	115" / 144"	96" / 144"	115" / 144"	N/A
Highland	Max Width / Max Height	96" / 70"	96" / 144"	118" / 144"	96" / 144"	118" / 144"	N/A
	Minimum Width	15 1/2"	15 1/2"	15 1/2"	15 1/2"	15 1/2"	15 1/2"
	Minimum Height	24"	24"	24"	24"	24"	24"

* Railroading this fabric results in a larger maximum width than the fabric width.

QMotion Tube Sizes: For 15 1/2" to 96", 2" tube; For 96" to 118", 2.4" tube; For 118" - 144", 3.25" tube

Motorized Shades - Size Standards Window Shades

	Q Motion Size Fascia Option	2.6 Q Motion With Fascia or Without Fascia	3.3 QMotion With Fascia or Without Fascia	3.3 QMotion With Fascia or Without Fascia	4.3 QMotion With Fascia Only	4.3 QMotion With Fascia Only	4.3 QMotion With Fascia Only
	Shade Width	15 1/2" - 96"	15 1/2" - 96"	96"-118"	15 1/2" - 96"	96" - 118"	118" - 144"
Hombre - Serged Edge	Max Width / Max Height	72" / 100"	72" / 144"	N/A	72" / 144"	N/A	N/A
Homespun	Max Width / Max Height	79" / 110"	79" / 144"	N/A	79" / 144"	N/A	N/A
Jackson	Max Width / Max Height	72" / 30"	72" / 100"	N/A	72" / 144"	N/A	N/A
Katrina	Max Width / Max Height	96" / 130"	96" / 144"	98" / 144"	96" / 144"	98" / 144"	N/A
Keilani	Max Width / Max Height	96" / 50"	96" / 144"	108" / 90"	96" / 144"	108" / 144"	N/A
Kendo	Max Width / Max Height	94" / 60"	94" / 144"	N/A	94" / 144"	N/A	N/A
Lexie	Max Width / Max Height	96" / 110"	96" / 144"	110" / 144"	96" / 110"	110" / 144"	N/A
Light-Vue	Max Width / Max Height	N/A	N/A	N/A	N/A	N/A	N/A
Lindley- Serged Edge	Max Width / Max Height	72" / 70"	72" / 144"	N/A	72" / 144"	N/A	N/A
Linen	Max Width / Max Height	78" / 90"	78" / 144"	N/A	78" / 144"	N/A	N/A
Lizzy	Max Width / Max Height	86" / 144"	86" / 144"	N/A	86" / 144"	N/A	N/A
Long Bay	Max Width / Max Height	96" / 80"	96" / 144"	110" / 144"	96" / 144"	110" / 144"	N/A
Long Bay Blackout	Max Width / Max Height	96" / 60"	96" / 144"	106" / 110"	96" / 144"	106" / 144"	N/A
Loretta	Max Width / Max Height	72" / 110"	72" / 144"	N/A	72" / 144"	N/A	N/A
Lucinda	Max Width / Max Height	72" / 120"	72" / 144"	N/A	72" / 144"	N/A	N/A
Luminescence	Max Width / Max Height	N/A	N/A	N/A	N/A	N/A	N/A
Lux Screen	Max Width / Max Height	96" / 80"	96" / 144"	98" / 144"	96" / 144"	98" / 144"	N/A
Moire	Max Width / Max Height	72" / 144"	72" / 144"	N/A	72" / 144"	N/A	N/A
Mystic	Max Width / Max Height	96" / 110"	96" / 144"	108" / 144"	96" / 144"	108" / 144"	N/A
Mystic Eclipse	Max Width / Max Height	96" / 60"	96" / 144"	110" / 110"	96" / 144"	110" / 144"	N/A
Net 3000	Max Width / Max Height	96" / 90"	96" / 144"	118" / 144"	96" / 144"	118" / 144"	144** / 144"
No-Lite Fiberglass - Duplex and Solids	Max Width / Max Height	96** / 110"	96** / 144"	118** / 144"	96** / 144"	118** / 144"	144** / 144"
Nordicscreen Plus BW (3% and 5%) or Twill (1% or 3%)	Max Width / Max Height	96" / 90"	96" / 144"	118" / 144"	96" / 144"	118" / 144"	N/A
Opulence	Max Width / Max Height	96" / 40"	96" / 110"	118" / 80"	96" / 144"	118" / 144"	N/A
Origami	Max Width / Max Height	96" / 80"	96" / 144"	108" / 144"	96" / 144"	108" / 144"	N/A
Pacifica	Max Width / Max Height	96" / 70"	96" / 144"	110" / 144"	96" / 144"	110" / 144"	N/A
Palm Beach	Max Width / Max Height	96" / 80"	96" / 144"	118" / 144"	96" / 144"	118" / 144"	N/A
	Minimum Width	15 1/2"	15 1/2"	15 1/2"	15 1/2"	15 1/2"	15 1/2"
	Minimum Height	24"	24"	24"	24"	24"	24"

* Railroading this fabric results in a larger maximum width than the fabric width.

QMotion Tube Sizes: For 15 1/2" to 96", 2" tube; For 96" to 118", 2.4" tube; For 118" - 144", 3.25" tube

Motorized Shades - Size Standards Window Shades

	Q Motion Size Fascia Option	2.6 Q Motion With Fascia or Without Fascia	3.3 QMotion With Fascia or Without Fascia	3.3 QMotion With Fascia or Without Fascia	4.3 QMotion With Fascia Only	4.3 QMotion With Fascia Only	4.3 QMotion With Fascia Only
	Shade Width	15 1/2" - 96"	15 1/2" - 96"	96"-118"	15 1/2" - 96"	96" - 118"	118" - 144"
Pearlescent	Max Width / Max Height	96** / 90"	96** / 144"	118** / 144"	96** / 144"	118** / 144"	144** / 144"
Persia	Max Width / Max Height	96" / 90"	96" / 144"	110" / 144"	96" / 144"	110" / 144"	N/A
Petticoat	Max Width / Max Height	N/A	N/A	N/A	N/A	N/A	N/A
Princeton	Max Width / Max Height	78" / 144"	78" / 144"	N/A	78" / 144"	N/A	N/A
Reserved	Max Width / Max Height	94" / 110"	94" / 144"	N/A	94" / 144"	N/A	N/A
Rocky Mountain - Serged Edge	Max Width / Max Height	70" / 50"	70" / 144"	N/A	70" / 144"	N/A	N/A
Rollie - Serged Edge	Max Width / Max Height	96** / 80"	96** / 144"	118** / 144"	96** / 144"	118** / 144"	144** / 144"
S Screen Elements	Max Width / Max Height	96" / 40"	96" / 120"	118" / 90"	96" / 144"	118" / 144"	122" / 110"
S Screen Origins	Max Width / Max Height	96" / 40"	96" / 120"	118" / 90"	96" / 144"	118" / 144"	122" / 110"
Safari	Max Width / Max Height	72" / 60"	72" / 144"	N/A	72" / 144"	N/A	N/A
Scala Blackout	Max Width / Max Height	96" / 120"	96" / 144"	110" / 120"	96" / 144"	110" / 144"	N/A
Seclusion	Max Width / Max Height	96" / 144"	96" / 144"	118" / 144"	96" / 144"	118" / 144"	144** / 144"
Sedona	Max Width / Max Height	96" / 70"	96" / 144"	110" / 144"	96" / 144"	110" / 144"	N/A
Serene	Max Width / Max Height	96" / 90"	96" / 144"	98" / 144"	96" / 144"	98" / 144"	N/A
Seto 5000	Max Width / Max Height	96" / 144"	96" / 144"	110" / 144"	96" / 144"	110" / 144"	N/A
Seto 6000	Max Width / Max Height	96" / 144"	96" / 144"	110" / 144"	96" / 144"	110" / 144"	N/A
Shantung	Max Width / Max Height	79" / 60"	79" / 144"	N/A	79" / 144"	N/A	N/A
SheerWeave 1000	Max Width / Max Height	96" / 90"	96" / 144"	N/A	96" / 144"	N/A	N/A
SheerWeave 2000	Max Width / Max Height	96" / 100"	96" / 144"	118" / 144"	96" / 144"	118" / 144"	144** / 144"
SheerWeave 2390	Max Width / Max Height	96" / 110"	96" / 144"	118" / 144"	96" / 144"	118" / 144"	144** / 144"
SheerWeave 2410	Max Width / Max Height	96" / 100"	96" / 144"	118" / 144"	96" / 144"	118" / 144"	144** / 144"
SheerWeave 2500	Max Width / Max Height	96" / 80"	96" / 144"	118" / 144"	96" / 144"	118" / 144"	144** / 144"
SheerWeave 3000	Max Width / Max Height	96" / 60"	96" / 144"	N/A	96" / 144"	N/A	N/A
SheerWeave 4100	Max Width / Max Height	96" / 50"	96" / 144"	118** / 110"	96" / 144"	118** / 144"	144** / 144"
SheerWeave 4400	Max Width / Max Height	96" / 40"	96" / 130"	118" / 90"	96" / 144"	118" / 144"	126" / 120"
SheerWeave 5000	Max Width / Max Height	96" / 40"	96" / 130"	98" / 90"	96" / 144"	98" / 144"	N/A
SheerWeave 7000	Max Width / Max Height	96" / 110"	96" / 144"	118" / 144"	96" / 144"	118" / 144"	144** / 144"
Sheerweave 7400	Max Width / Max Height	96" / 70"	96" / 144"	118" / 120"	96" / 144"	118" / 144"	N/A
	Minimum Width	15 1/2"	15 1/2"	15 1/2"	15 1/2"	15 1/2"	15 1/2"
	Minimum Height	24"	24"	24"	24"	24"	24"

* Railroading this fabric results in a larger maximum width than the fabric width.

QMotion Tube Sizes: For 15 1/2" to 96", 2" tube; For 96" to 118", 2.4" tube; For 118" - 144", 3.25" tube

Motorized Shades - Size Standards Window Shades

	Q Motion Size Fascia Option	2.6 Q Motion With Fascia or Without Fascia	3.3 QMotion With Fascia or Without Fascia	3.3 QMotion With Fascia or Without Fascia	4.3 QMotion With Fascia Only	4.3 QMotion With Fascia Only	4.3 QMotion With Fascia Only
	Shade Width	15 1/2" - 96"	15 1/2" - 96"	96"-118"	15 1/2"- 96"	96" - 118"	118" - 144"
Sheerweave 7450	Max Width / Max Height	96" / 110"	96" / 144"	118" / 144"	96" / 144"	118" / 144"	N/A
SheerWeave Infinity 2 3% or 5%	Max Width / Max Height	96" / 60"	96" / 144"	98" / 110"	96" / 144"	98" / 144"	N/A
SheerWeave Perf+ 2390	Max Width / Max Height	96" / 110"	96" / 144"	N/A	96" / 144"	N/A	N/A
SheerWeave Perf+ 2410	Max Width / Max Height	96" / 110"	96" / 144"	N/A	96" / 144"	N/A	N/A
Solar Screen 1% or 3%	Max Width / Max Height	96" / 90"	96" / 144"	118" / 144"	96" / 144"	118" / 144"	N/A
Spector	Max Width / Max Height	84" / 144"	84" / 144"	N/A	84" / 144"	N/A	N/A
Spiral- Serged Edge	Max Width / Max Height	96" / 110"	96" / 144"	102" / 144"	96" / 144"	102" / 144"	N/A
Strata	Max Width / Max Height	81" / 144"	81" / 144"	N/A	81" / 144"	N/A	N/A
Strie- Serged Edge	Max Width / Max Height	72" / 60"	72" / 144"	N/A	72" / 144"	N/A	N/A
SuperWide	Max Width / Max Height	96" / 144"	96" / 144"	118** / 144"	96" / 144"	118** / 144"	144** / 144"
T Screen with KOOLBLACK Technology 3% or 5%	Max Width / Max Height	96" / 60"	96" / 144"	118" / 120"	96" / 144"	118" / 144"	122" / 144"
Tahiti	Max Width / Max Height	N/A	70" / 70"	N/A	70" / 144"	N/A	N/A
Triad	Max Width / Max Height	96" / 50"	96" / 144"	118" / 100"	96" / 144"	118" / 144"	N/A
Tussah	Max Width / Max Height	96" / 130"	96" / 144"	110" / 144"	96" / 144"	110" / 144"	N/A
Valencia	Max Width / Max Height	94" / 120"	94" / 144"	N/A	94" / 144"	N/A	N/A
Viking	Max Width / Max Height	96** / 120"	96** / 120"	118** / 120"	96** / 120"	118** / 120"	120** / 120"
Vision	Max Width / Max Height	96" / 80"	96" / 144"	118" / 144"	96" / 144"	118" / 144"	N/A
Vista Screen	Max Width / Max Height	N/A	96" / 90"	98" / 60"	96" / 144"	98" / 144"	N/A
Vizela	Max Width / Max Height	94" / 120"	94" / 144"	N/A	94" / 144"	N/A	N/A
Wave	Max Width / Max Height	72" / 75"	72" / 144"	N/A	72" / 144"	N/A	N/A
Weave	Max Width / Max Height	72" / 60"	72" / 144"	N/A	72" / 144"	N/A	N/A
Willow	Max Width / Max Height	72" / 90"	72" / 144"	N/A	72" / 144"	N/A	N/A
Yellowstone	Max Width / Max Height	72" / 50"	72" / 144"	N/A	72" / 144"	N/A	N/A
Zootime	Max Width / Max Height	86" / 60"	86" / 144"	N/A	86" / 144"	N/A	N/A
	Minimum Width	15 1/2"	15 1/2"	15 1/2"	15 1/2"	15 1/2"	15 1/2"
	Minimum Height	24"	24"	24"	24"	24"	24"

* Railroading this fabric results in a larger maximum width than the fabric width.

QMotion Tube Sizes: For 15 1/2" to 96", 2" tube; For 96" to 118", 2.4" tube; For 118" - 144", 3.25" tube

Quick Reference

Window Shade Type and Design Options Cross Reference

Options Availability	Clutch System	Decorative Clutch	Sure-Lift	EZ Pull	Cordless EZ Lift	Spring Roller	Top Down	Season-Vue	Light Blockout	Notes
No Charge Options										
Bead Chain Sub/Custom Drop	✓	✓	⊘	✓	⊘	⊘	✓	✓	✓	
Bottom Hem - Heat Sealed	✓	✓	✓	✓	✓	✓	⊘	⊘	⊘	See pages 62-63 for exclusions
Clutch Color Substitution	✓	⊘	⊘	⊘	⊘	⊘	✓	✓	✓	
P Clip Safety Tensioner	✓	✓	⊘	✓	⊘	⊘	✓	✓	✓	
R Series Clutch Substitution	✓	⊘	⊘	⊘	⊘	⊘	std	✓	std	
Reverse Roll	✓	✓	⊘	✓	✓	✓	⊘	✓	⊘	
Sewn In Hem	✓	✓	✓	✓	✓	✓	std	✓	std	
Surcharge Options										
2-on-1 Headrail	✓	⊘	⊘	⊘	⊘	⊘	⊘	✓	⊘	Cassette or Board Mounted
Bead Chain - Metal	✓	✓	⊘	✓	⊘	⊘	✓	✓	✓	
Board Mounted Shade	✓	⊘	⊘	✓	✓	✓	⊘	⊘	⊘	
Bottom Hem - Decorative Hem	✓	✓	✓	✓	✓	✓	⊘	⊘	⊘	
Bottom Hem - Wood	✓	✓	✓	✓	⊘	⊘	⊘	⊘	⊘	Max 60" wide or 72" wide
Cassette - Small	✓	⊘	⊘	⊘	✓	⊘	⊘	⊘	⊘	2-on-1 Available - Surcharge
Cassette - Large	✓	⊘	⊘	✓	✓	⊘	⊘	✓	⊘	2-on-1 Available - Surcharge
Cassette - Sure-Lift	⊘	⊘	✓	⊘	⊘	⊘	⊘	⊘	⊘	
Clutch - Galaxy 400 Spring Assist	✓	⊘	⊘	⊘	⊘	⊘	⊘	⊘	⊘	
Clutch & Bracket - Satin Nickel	SL only	⊘	⊘	⊘	⊘	⊘	⊘	⊘	⊘	SL 10 and SL 20 only
Cornice - 4" or 7" Fabric	✓	✓	⊘	✓	✓	✓	⊘	⊘	⊘	
Exterior Cable Guide System	SL brckt	⊘	⊘	⊘	⊘	⊘	⊘	✓	⊘	96" x 96" max shade size
Fascia - 3" Flat	✓	⊘	⊘	⊘	⊘	⊘	✓	✓	✓	Adj 3" Bracket - Surcharge
Fascia - 4" Flat	✓	⊘	⊘	⊘	⊘	⊘	✓	✓	✓	Adj 4" Bracket - Surcharge
Fascia - 5" Flat	✓	⊘	⊘	⊘	⊘	⊘	⊘	✓	⊘	Dual Shade - Surcharge
Fascia - 5" Pocket	✓	⊘	⊘	⊘	⊘	⊘	⊘	⊘	⊘	Gravity Lip - Surcharge
Fascia - Fabric Wrapped	✓	⊘	⊘	⊘	⊘	⊘	✓	⊘	✓	See pages 62-63 for exclusions
Magnetic Hold Down	✓	✓	✓	✓	✓	✓	⊘	✓	⊘	
Mixed Metals - Designer Accents	✓	⊘	⊘	✓	✓	⊘	⊘	✓	⊘	Cassette & Fascia Only
Valance - Channel Panel	✓	✓	⊘	✓	✓	✓	⊘	⊘	⊘	See pages 62-63 for exclusions
Valance - Fabric Wrapped Stand Alone	✓	✓	⊘	✓	✓	✓	✓	⊘	⊘	See pages 62-63 for exclusions
Valance - Shade	✓	✓	⊘	✓	✓	✓	✓	⊘	⊘	See pages 62-63 for exclusions
Valance - Wd Majesty, Noble, Camelot	✓	✓	⊘	✓	✓	✓	⊘	⊘	⊘	
Tube Size Upgrade	✓	⊘	✓	⊘	⊘	✓	⊘	✓	⊘	
Notes		OS Mount Only	fabric covered				SL Bracket			

All shade styles are available with Antimicrobial or Flame Retardant treatment. Allow 4 to 6 weeks for outside vendor service.

Motorization Options . . . and More Options!								
Options Availability	System II	Sonessa 30 Wirefree	EZ Charge V 2.0	EZ Charge X2	EZ Charge X3	Auto Wand	Q Motion	Notes
No Charge Options								
R Series Bracket Substitution	✓	✓	✓	✓	✓	Required	⊘	
Reverse Roll	✓	✓	✓	✓	✓	✓	✓	
Sewn in Hem	✓	✓	✓	✓	✓	✓	⊘	
Wrapped Metal Hemline	✓	✓	✓	✓	✓	✓	Required	
Surcharge Options								
Board Mounted Shade	✓	✓	✓	✓	✓	✓	✓	
Cassette - Small	✓	✓	✓	✓	⊘	✓	⊘	
Cassette - Large	✓	✓	✓	✓	⊘	✓	⊘	
Fascia	✓	✓	✓	✓	✓	⊘	✓	
Mixed Metals Designer Accents	✓	✓	✓	✓	✓	✓	✓	Available with Cassette or Fascia
Valance - Board Mtd Wd Majesty or Noble	✓	✓	✓	✓	✓	✓	✓	
Surcharge Options - Motor Accessories								
App Interface	✓	✓	✓	✓	✓	⊘	✓	
Charger Unit - 96" Extension	⊘	✓	✓	✓	✓	⊘	⊘	
Charger - 6 Ft Micro USB	⊘	⊘	⊘	⊘	⊘	✓	⊘	
Home Automation Interface	✓	✓	✓	✓	✓	⊘	✓	
Remote - Single Channel	✓	✓	⊘	⊘	⊘	⊘	✓	
Remote - Multi Channel	✓	✓	✓	✓	✓	⊘	✓	
Wall Switch Control	✓	✓	✓	✓	✓	⊘	✓	

Quick Reference - Screen Shades

- Fabrics are often chosen for their aesthetic appeal without thinking about controlling the sun or daylighting needs.
- Screen shade fabrics reduce solar heat gain and glare.
- To help your customer choose the right fabric, identify their priorities . Which is more important? Reducing solar heat and glare or maintaining a view of the outdoors.
- Light colors, such as white, reflect solar energy away from the interior but diffuse light creating glare and limited views.
- Dark colors absorb solar heat and light allowing excellent outside views but transmit heat into the room.
- Color and openness factor are the most important features to consider for energy savings, light management, and visibility.
- Openness factors can be determined by measuring the surface area the fabric covers or by the percent of light transmission. The more open the fabric the better the outward views and the more light and heat enter the room. (See chart below for openness % for each screen material).
- Selecting the right combination of color and openness can maximize performance and ensure a successful sale.
- **For complete testing and specifications see the Genesis Technical Specification in the Dealer Center on the web site.**

Fabric Name	Openness	Fabric Width	Available Railroaded	Eco Certification	FR Rated	Fabric Composition
Brit	5%	98"		Greenguard	NFPA 701	70% PVC, 30% Polyester
Deco Screen	5%	98"		Greenguard	NFPA 701	36% Fiberglass, 64% Vinyl
Dimensions (M Screen) 3% / 5%	3% / 5%	120"		Greenguard	NFPA 701	36% Fiberglass, 64% PVC
Duo Vue	1%	98"		Greenguard	NFPA 701	70% PVC, 30% Polyester
E Screen KOOLBLACK 3% / 5%	3% / 5%	122"		Greenguard	NFPA 701	36% Fiberglass, 64% Vinyl
E Screen 3% / 5%	3% / 5%	122"		Greenguard	NFPA 701	36% Fiberglass, 64% PVC
Economy Screen	7%	118"		Greenguard	NFPA 701	70% PVC, 30% Polyester
Lux Screen	3%	98"			NFPA 701	72% PVC, 28% Polyester
Net 3000	5%	118"	✓	Greenguard	NFPA 701	27% Polyester, 73%PVC
Nordicscreen Plus BW 3% / 5%	3% / 5%	118"		Greenguard	NFPA 701	78% PVC, 22% Polyester
Nordicscreen Plus Twill 1% / 3%	1% / 3%	118"		Greenguard	NFPA 701	78% PVC, 22% Polyester
Opulence	10%	118"		Greenguard	NFPA 701	25.3% Polyester, 74.7% Green PVC
S Screen Elements / Origins	4%	122"		Greenguard	NFPA 701	33.6% Fiberglass / 59.6% Vinyl 6.8% Poly
SheerWeave 1000	25%	96"		Greenguard	NFPA 701	35% Fiberglass, 65% PVC on Fiberglass
SheerWeave 2000	5%	126"	✓	Greenguard	NFPA 701	37% Fiberglass, 63% PVC on Fiberglass
SheerWeave 2390	5%	126"	✓	Greenguard	NFPA 701	35% Fiberglass, 65% Vinyl on Fiberglass
SheerWeave 2410	3%	126"	✓	Greenguard	NFPA 701	35% Fiberglass, 65% Vinyl on Fiberglass
SheerWeave 2500	1%	126"	✓	Greenguard	NFPA 701	37% Fiberglass, 63% Vinyl on Fiberglass
SheerWeave 3000	14%	96"		Greenguard	NFPA 701	35% Fbrglss, 65% PVC, 31% Poly, 69% Vinyl on Poly
SheerWeave 4100	10%	98"	✓	Greenguard	NFPA 701	25% Polyester, 75% PVC on Polyester
SheerWeave 4400	3%	126"		Greenguard	NFPA 701	25% Polyester, 75% PVC on Polyester
SheerWeave 5000 Bamboo Brchbrk	10%	98"		Greenguard	NFPA 701	28% Polyester, 72% Vinyl on Polyester
SheerWeave 5000 Bamboo Wheat	7%	98"		Greenguard	NFPA 701	27.5% Polyester, 67% Vinyl on Polyester, 5.5% Acrylic
SheerWeave 5000 Bark Ash	5%	98"		Greenguard	NFPA 701	28% Polyester, 72% Vinyl on Polyester
SheerWeave 5000 Bark Pewter	5%	98"		Greenguard	NFPA 701	28% Polyester, 72% Vinyl on Polyester
SheerWeave 5000 Bark Tigereye	5%	98"		Greenguard	NFPA 701	27.5% Polyester, 67% Vinyl on Polyester, 5.5% Acrylic
SheerWeave 5000 Chenille Drftwd	5%	98"		Greenguard	CA 117	49% Polyester, 51% Vinyl on Polyester
SheerWeave 5000 Chenille Honey	3%	98"		Greenguard	CA 117	49% Polyester, 51% Vinyl on Polyester
SheerWeave 5000 Chenille Mrshmw	3%	98"		Greenguard	CA 117	49% Polyester, 51% Vinyl on Polyester
SheerWeave 5000 Hnyomb Nugget	10%	98"		Greenguard	NFPA 701	26% Polyester, 68% Vinyl on Polyester, 6% Acrylic
SheerWeave 5000 Jute Parchment	1%	98"		Greenguard	CA 117	49% Polyester, 51% Vinyl on Polyester
SheerWeave 5000 Linen Cinnamon	3%	98"		Greenguard	CA 117	45% Polyester, 55% Vinyl on Polyester
SheerWeave 5000 Linen Clay	7%	98"		Greenguard	NFPA 701	28% Polyester, 72% Vinyl on Polyester
SheerWeave 5000 Linen Cream	5%	98"		Greenguard	CA 117	43% Polyester, 57% Vinyl on Polyester
SheerWeave 5000 Linen Cranberry	3%	98"		Greenguard	CA 117	45% Polyester, 55% Vinyl on Polyester
SheerWeave 5000 Linen Fig	3%	98"		Greenguard	CA 117	45% Polyester, 55% Vinyl on Polyester
SheerWeave 5000 Linen Pearl	5%	98"		Greenguard	NFPA 701	28% Polyester, 72% Vinyl on Polyester
SheerWeave 5000 Linen Taupe	5%	98"		Greenguard	NFPA 701	28% Polyester, 72% Vinyl on Polyester
SheerWeave 5000 Marble Sand	5%	98"		Greenguard	NFPA 701	28% Polyester, 72% Vinyl on Polyester
SheerWeave 5000 Metro Platinum	5%	98"		Greenguard	CA 117	67% Vinyl on Polyester, 26% Polyester, 7% Olefin
SheerWeave 5000 Rattan Umber	7%	98"		Greenguard	NFPA 701	27.5% Polyester, 67% Vinyl on Polyester, 5.5% Acrylic
SheerWeave 5000 Tweed Buckeye	5%	98"		Greenguard	CA 117	37% Polyester, 63% Vinyl on Polyester
SheerWeave 5000 Tweed Oatmeal	5%	98"		Greenguard	CA 117	37% Polyester, 64% Vinyl on Polyester
SheerWeave 5000 Wicker Mshrm	5%	98"		Greenguard	NFPA 701	27.5% Polyester, 67% Vinyl on Polyester, 5.5% Acrylic
SheerWeave 5000 Wicker Straw	3%	98"		Greenguard	CA 117	49% Polyester, 51% Vinyl on Polyester
SheerWeave Infinity 2 3% / 5%	3% / 5%	98"		Greenguard	NFPA 701	100% TPO-20% TPO fiber yarn/80% TPO Coating/Yarn
SheerWeave Perf+ 2390	5%	96"		Greenguard	NFPA 701	34% Fbrglss, 64% Vinyl on Fbrglss & 2% Alum Coating
SheerWeave Perf+ 2410	3%	96"		Greenguard	NFPA 701	34% Fbrglss, 64% Vinyl on Fbrglss & 2% Alum Coating
Solar Screen 3000 1% / 3%	1% / 3%	118"		Greenguard	NFPA 701	30% Polyester, 70% PVC
T Screen KOOLBLACK 3% / 5%	3% / 5%	122"		Greenguard	NFPA 701	36% Fiberglass, 64% Vinyl
Triad	3%	118"		Greenguard	NFPA 701	70% PVC, 30% Polyester
Vision	5%	118"		Oeko-tex 100	NFPA 701	30% Polyester, 70% PVC
Vista Screen	4%	98"		Oeko-tex 100	NFPA 701	4% vacuum aluminum layer, 28% Poly, 68% PVC

Size Standards Flat Roman Shades

Sizes shown are Maximum Width / Maximum Height

	Cord Lock/ Clutch system	Multiple Blinds Cord/Clutch	CareRING Cordless	Top Down Bottom Up	Arch Top/ Angle Top	Flat Arch	Flat Angle
Adele	98" / 120"	192" / 120"	78" / 84"	98" / 96"	60" / 108"	60" / 30"	60" / 48"
Beatty - Serged Edge	72" / 120"	192" / 120"	72" / 84"	72" / 96"	60" / 108"	60" / 30"	60" / 48"
Berber Slub	72" / 120"	192" / 120"	72" / 84"	72" / 96"	60" / 108"	60" / 30"	60" / 48"
Boho	94" / 120"	192" / 120"	78" / 84"	94" / 96"	N/A	N/A	60" / 48"
Cabos	98" / 120"	192" / 120"	78" / 84"	98" / 96"	60" / 108"	60" / 30"	60" / 48"
Cayman	98" / 120"	192" / 120"	78" / 84"	98" / 96"	60" / 108"	60" / 30"	60" / 48"
Charmed	98" / 120"	192" / 120"	78" / 84"	98" / 96"	N/A	N/A	N/A
Dakota	90" / 120"	192" / 120"	78" / 84"	90" / 96"	60" / 108"	60" / 30"	60" / 48"
Dallas	72" / 120"	192" / 120"	72" / 84"	72" / 96"	60" / 108"	60" / 30"	60" / 48"
Dimensions	98" / 120"	192" / 120"	78" / 84"	98" / 96"	60" / 108"	60" / 30"	60" / 48"
E Screen	98" / 120"	192" / 120"	78" / 84"	98" / 96"	60" / 108"	60" / 30"	60" / 48"
E Screen KoolBlack	98" / 120"	192" / 120"	78" / 84"	98" / 96"	60" / 108"	60" / 30"	60" / 48"
Fedora - Serged Edge	72" / 120"	192" / 120"	72" / 84"	72" / 96"	60" / 108"	60" / 30"	60" / 48"
Flutter	96" / 120"	192" / 120"	78" / 84"	96" / 96"	60" / 108"	60" / 30"	60" / 48"
Garbo	98" / 120"	192" / 120"	78" / 84"	98" / 96"	N/A	N/A	N/A
Grasscloth	72" / 120"	192" / 120"	72" / 84"	72" / 96"	60" / 108"	60" / 30"	60" / 48"
Hombre - Serged Edge	72" / 120"	192" / 120"	72" / 84"	72" / 96"	60" / 108"	60" / 30"	60" / 48"
Homespun	79" / 120"	192" / 120"	78" / 84"	79" / 96"	60" / 108"	60" / 30"	60" / 48"
Jackson	72" / 120"	192" / 120"	72" / 84"	72" / 96"	60" / 108"	60" / 30"	60" / 48"
Keilani	98" / 120"	192" / 120"	78" / 84"	98" / 96"	60" / 108"	60" / 30"	60" / 48"
Kendo	94" / 120"	192" / 120"	78" / 84"	94" / 96"	60" / 108"	60" / 30"	60" / 48"
Lizzy	86" / 120"	192" / 120"	78" / 84"	86" / 96"	60" / 108"	60" / 30"	60" / 48"
Long Bay	98" / 120"	192" / 120"	78" / 84"	98" / 96"	N/A	N/A	N/A
Loretta	72" / 120"	192" / 120"	72" / 84"	72" / 96"	60" / 108"	60" / 30"	60" / 48"
Lux Screen	98" / 120"	192" / 120"	78" / 84"	98" / 96"	60" / 108"	60" / 30"	60" / 48"
Mystic	98" / 120"	192" / 120"	78" / 84"	98" / 96"	N/A	N/A	N/A
Net 3000	98" / 120"	192" / 120"	78" / 84"	98" / 96"	60" / 108"	60" / 30"	60" / 48"
Origami	98" / 120"	192" / 120"	78" / 84"	98" / 96"	60" / 108"	60" / 30"	60" / 48"
Persia	98" / 120"	192" / 120"	78" / 84"	98" / 96"	60" / 108"	60" / 30"	60" / 48"
Reserved	94" / 120"	192" / 120"	78" / 84"	94" / 96"	N/A	N/A	N/A
Rocky Mountain-Serged Edge	70" / 120"	192" / 120"	70" / 84"	70" / 96"	60" / 108"	60" / 30"	60" / 48"
Shantung	79" / 120"	192" / 120"	78" / 84"	79" / 96"	60" / 108"	60" / 30"	60" / 48"
SheerWeave 1000	84" / 120"	192" / 120"	78" / 84"	84" / 96"	60" / 108"	60" / 30"	60" / 48"
SheerWeave 2000	98" / 120"	192" / 120"	78" / 84"	98" / 96"	60" / 108"	60" / 30"	60" / 48"
SheerWeave 2390	98" / 120"	192" / 120"	78" / 84"	98" / 96"	60" / 108"	60" / 30"	60" / 48"
SheerWeave 2410	98" / 120"	192" / 120"	78" / 84"	98" / 96"	60" / 108"	60" / 30"	60" / 48"
SheerWeave 2500	98" / 120"	192" / 120"	78" / 84"	98" / 96"	60" / 108"	60" / 30"	60" / 48"
SheerWeave 3000	96" / 120"	192" / 120"	78" / 84"	96" / 96"	60" / 108"	60" / 30"	60" / 48"
Sheerweave 7450	98" / 120"	192" / 120"	78" / 84"	98" / 96"	60" / 108"	60" / 30"	60" / 48"
Strie - Serged Edge	72" / 120"	192" / 120"	72" / 84"	72" / 96"	60" / 108"	60" / 30"	60" / 48"
T Screen with KOOLBLACK	98" / 120"	192" / 120"	78" / 84"	96" / 96"	60" / 108"	60" / 30"	96" / 96"
Tahiti	70" / 120"	192" / 120"	70" / 84"	70" / 96"	60" / 108"	60" / 30"	60" / 48"
Vista Screen	98" / 120"	192" / 120"	78" / 84"	98" / 96"	60" / 108"	60" / 30"	60" / 48"
Vizela	94" / 120"	192" / 120"	78" / 84"	94" / 96"	60" / 108"	60" / 30"	60" / 48"
Willow	72" / 120"	192" / 120"	72" / 84"	72" / 96"	60" / 108"	60" / 30"	60" / 48"
Yellowstone	72" / 120"	192" / 120"	72" / 84"	72" / 96"	N/A	N/A	60" / 48"
Minimum Width	11"/15" or 24**	11"/15" or 24"/shade*	18 1/2" **	24"	16" Arch/24" Angle	16"	12"
Minimum Height	24"	24"	24"	24"	24"	8"	12"

*Quick Lift Clutch is 15", Traditional Clutch is 24"

** For widths 18 1/2" to 26 1/2", shades are available up to 56" long.

Motorized Shades - Size Standards

Flat Roman Shades

Sizes shown are Maximum Width / Maximum Height / Maximum Area in Square Feet

	System II Battery Pages 44-45	Sonessa 30 Wirefree Pages 44-45	EZ Charge Version 2.0 Pages 46-47	EZ Charge X2 Motor Pages 46-47	Auto-Wand System Page 43
Adele	96" / 96" / 50	96" / 96" / 64	96" / 96" / 50	96" / 96" / 64	96" / 96" / 50
Beatty - Serged Edge	72" / 96" / 50	72" / 96" / 64	72" / 96" / 50	72" / 96" / 64	72" / 96" / 50
Berber Slub	72" / 96" / 50	72" / 96" / 64	72" / 96" / 50	72" / 96" / 64	72" / 96" / 50
Boho	94" / 96" / 50	94" / 96" / 64	94" / 96" / 50	94" / 96" / 64	94" / 96" / 50
Cabos	96" / 96" / 50	96" / 96" / 64	96" / 96" / 50	96" / 96" / 64	96" / 96" / 50
Cayman	96" / 96" / 50	96" / 96" / 64	96" / 96" / 50	96" / 96" / 64	96" / 96" / 50
Charmed	96" / 96" / 50	96" / 96" / 64	96" / 96" / 50	96" / 96" / 64	96" / 96" / 50
Dakota	90" / 96" / 50	90" / 96" / 64	90" / 96" / 50	90" / 96" / 64	90" / 96" / 50
Dallas	72" / 96" / 50	72" / 96" / 64	72" / 96" / 50	72" / 96" / 64	72" / 96" / 50
Dimensions	96" / 96" / 50	96" / 96" / 64	96" / 96" / 50	96" / 96" / 64	96" / 96" / 50
E Screen	96" / 96" / 50	96" / 96" / 64	96" / 96" / 50	96" / 96" / 64	96" / 96" / 50
E Screen KoolBlack	96" / 96" / 50	96" / 96" / 64	96" / 96" / 50	96" / 96" / 64	96" / 96" / 50
Fedora - Serged Edge	72" / 96" / 50	72" / 96" / 64	72" / 96" / 50	72" / 96" / 64	72" / 96" / 50
Flutter	96" / 96" / 50	96" / 96" / 64	96" / 96" / 50	96" / 96" / 64	96" / 96" / 50
Garbo	96" / 96" / 50	96" / 96" / 64	96" / 96" / 50	96" / 96" / 64	96" / 96" / 50
Grasscloth	72" / 96" / 50	72" / 96" / 64	72" / 96" / 50	72" / 96" / 64	72" / 96" / 50
Hombre - Serged Edge	72" / 96" / 50	72" / 96" / 64	72" / 96" / 50	72" / 96" / 64	72" / 96" / 50
Homespun	79" / 96" / 50	79" / 96" / 64	79" / 96" / 50	79" / 96" / 64	79" / 96" / 50
Jackson	72" / 96" / 50	72" / 96" / 64	72" / 96" / 50	72" / 96" / 64	72" / 96" / 50
Keilani	96" / 96" / 50	96" / 96" / 64	96" / 96" / 50	96" / 96" / 64	96" / 96" / 50
Kendo	94" / 96" / 50	94" / 96" / 64	94" / 96" / 50	94" / 96" / 64	94" / 96" / 50
Lizzy	86" / 96" / 50	86" / 96" / 64	84" / 96" / 50	86" / 96" / 64	86" / 96" / 50
Long Bay	96" / 96" / 50	96" / 96" / 64	96" / 96" / 50	96" / 96" / 64	96" / 96" / 50
Loretta	72" / 96" / 50	72" / 96" / 64	72" / 96" / 50	72" / 96" / 64	72" / 96" / 50
Lux Screen	96" / 96" / 50	96" / 96" / 64	96" / 96" / 50	96" / 96" / 64	96" / 96" / 50
Mystic	96" / 96" / 50	96" / 96" / 64	96" / 96" / 50	96" / 96" / 64	96" / 96" / 50
Net 3000	96" / 96" / 50	96" / 96" / 64	96" / 96" / 50	96" / 96" / 64	96" / 96" / 50
Origami	96" / 96" / 50	96" / 96" / 64	96" / 96" / 50	96" / 96" / 64	96" / 96" / 50
Persia	96" / 96" / 50	96" / 96" / 64	96" / 96" / 50	96" / 96" / 64	96" / 96" / 50
Reserved	94" / 96" / 50	94" / 96" / 64	94" / 96" / 50	94" / 96" / 64	94" / 96" / 50
Rocky Mountain-Serged Edge	70" / 96" / 50	70" / 96" / 64	70" / 96" / 50	70" / 96" / 64	70" / 96" / 50
Shantung	79" / 96" / 50	79" / 96" / 64	79" / 96" / 50	79" / 96" / 64	79" / 96" / 50
SheerWeave 1000	96" / 96" / 50	96" / 96" / 64	96" / 96" / 50	96" / 96" / 64	96" / 96" / 50
SheerWeave 2000	96" / 96" / 50	96" / 96" / 64	96" / 96" / 50	96" / 96" / 64	96" / 96" / 50
SheerWeave 2390	96" / 96" / 50	96" / 96" / 64	96" / 96" / 50	96" / 96" / 64	96" / 96" / 50
SheerWeave 2410	96" / 96" / 50	96" / 96" / 64	96" / 96" / 50	96" / 96" / 64	96" / 96" / 50
SheerWeave 2500	96" / 96" / 50	96" / 96" / 64	96" / 96" / 50	96" / 96" / 64	96" / 96" / 50
SheerWeave 3000	96" / 96" / 50	96" / 96" / 64	96" / 96" / 50	96" / 96" / 64	96" / 96" / 50
Sheerweave 7450	96" / 96" / 50	96" / 96" / 64	96" / 96" / 50	96" / 96" / 64	96" / 96" / 50
Strie - Serged Edge	72" / 96" / 50	72" / 96" / 64	72" / 96" / 50	72" / 96" / 64	72" / 96" / 50
T Screen with KOOLBLACK	96" / 96" / 50	96" / 96" / 64	96" / 96" / 50	96" / 96" / 64	96" / 96" / 50
Tahiti	70" / 96" / 50	70" / 96" / 64	70" / 96" / 50	70" / 96" / 64	70" / 96" / 50
Vista Screen	96" / 96" / 50	96" / 96" / 64	96" / 96" / 50	96" / 96" / 64	96" / 96" / 50
Vizela	94" / 96" / 50	94" / 96" / 64	94" / 96" / 50	94" / 96" / 64	94" / 96" / 50
Willow	72" / 96" / 50	72" / 96" / 64	72" / 96" / 50	72" / 96" / 64	72" / 96" / 50
Yellowstone	72" / 96" / 50	72" / 96" / 64	72" / 96" / 50	72" / 96" / 64	72" / 96" / 50
Minimum Width	16"	29"	22"	32"	22"
Minimum Height	24"	24"	24"	24"	28"

Design Options Cross Reference

Flat Roman Shades

Options Availability	Cord Lock	Quick Lift Clutch	Traditional Clutch	Top Down Bottom Up	CareRING Cordless	Angle or Arch Top	Arch	Notes
No Charge Options								
Contemporary Style	✓	✓	✓	⊘	✓	✓	⊘	
Hold Down Brackets	✓	✓	✓	✓	⊘	✓	⊘	
Optional Cord Lengths	✓	⊘	⊘	✓	⊘	✓	⊘	
Optional Bead Chain Drops	⊘	✓	✓	⊘	⊘	✓	⊘	
Turned Headrail - Traditional Style	✓	⊘	⊘	⊘	⊘	⊘	⊘	
Turned Headrail - Contemporary Style	✓	⊘	⊘	⊘	⊘	✓	⊘	
Surcharge Options								
2-on-1 Headrail	✓	✓	✓	✓	✓	⊘	⊘	Surcharge per shade - Min width 16"
3-on-1 Headrail	✓	✓	✓	✓	✓	⊘	⊘	Surcharge per shade - Min width 16"
Banding - Dakota, Tahiti & Yellowstone	✓	✓	✓	✓	⊘	⊘	⊘	
Hold Down Brackets not available								
Gimp on Bottom - Winchester 112	✓	✓	✓	✓	✓	✓	⊘	Fabric Dependent
Lining - Tahiti & Yellowstone	✓	✓	✓	✓ w/ banding	✓	✓	⊘	Brass Rings show on lining
Valance Length Addition of 6"	✓	✓	✓	✓	✓	✓	⊘	
Notes				No Clutch		No Clutch		

All shade styles are available with Antimicrobial or Flame Retardant treatment. Allow 4 to 6 weeks for outside vendor service.

Flat Roman Shade Motorization Options . . . and More Options!						
Options Availability	System II	Sonessa 30 Wirefree	EZ Charge V 2.0	EZ Charge X2	Auto Wand	Notes
No Charge Options						
Contemporary Style	✓	✓	✓	✓	⊘	
Turned Headrail	⊘	⊘	⊘	⊘	⊘	
Surcharge Options - Shade						
2-on-1 Headrail	✓ Min 16" per shade	✓ Min 29" per shade	✓ Min 22" per shade	✓ Min 32" per shade	✓ Min 22" per shade	
3-on-1 Headrail	✓ Min 16" per shade	✓ Min 29" per shade	✓ Min 22" per shade	✓ Min 32" per shade	✓ Min 22" per shade	
Banding - Dakota, Tahiti & Yellowstone	✓	✓	✓	✓	✓	
Lining - Tahiti & Yellowstone	✓	✓	✓	✓	✓	Brass Rings show on lining
Valance Length Addition of 6"	✓	✓	✓	✓	✓	
Surcharge Options - Motor Accessories						
App Interface	✓	✓	✓	✓	⊘	
Charger Unit - 96" Extension	⊘	✓	✓	✓	⊘	
Charger - 6' Micro USB	⊘	⊘	⊘	⊘	✓	
Home Automation Interface	✓	✓	✓	✓	⊘	
Remote - Single Channel	✓	✓	⊘	⊘	⊘	
Remote - Multi Channel	✓	✓	✓	✓	⊘	
Wall Switch Control	✓	✓	✓	✓	⊘	

Size Standards - Genesis Panel Track

	Maximum Width	Maximum Height Cord Draw	Maximum Height Wand Draw	Minimum Height Cord Draw	Minimum Height Wand Draw
All Panel Track Shades	192"	144"	96"	39"	24"

Pricing Window Shades

Price Chart A		▶ Economy Screen (118")												
WINDOW SHADES														
WIDTH TO:		30"	36"	42"	48"	54"	60"	66"	72"	78"	84"	96"	108"	118"
WINDOW HEIGHT TO:	36"	\$82	93	104	113	127	138	151	164	209	247	278	327	369
	48"	89	100	113	127	142	160	173	189	236	264	300	356	404
	60"	98	111	127	136	153	173	191	207	256	284	331	382	447
	72"	102	118	133	151	171	189	207	227	291	331	373	418	493
	84"	122	133	151	167	182	200	224	244	342	373	398	449	542
	96"	127	142	164	182	196	222	244	264	373	404	438	493	602
	108"	131	151	173	191	211	236	258	282	396	451	493	531	658
120"	138	164	187	207	227	249	276	300	422	482	529	578	711	

Price Chart 1		▶ Fiber-Lucent (72" RR)						▶ Katrina (98")						
WINDOW SHADES		▶ No-Lite Fiberglass Solid (72" RR)						▶ Viking (TFR) (72" RR)						
		▶ Vision (118")												
WIDTH TO:		30"	36"	42"	48"	54"	60"	66"	72"	78"	84"	96"	108"	120"
WINDOW HEIGHT TO:	36"	\$93	102	116	124	140	156	169	180	233	276	307	360	409
	48"	98	111	124	138	160	178	191	209	258	296	333	398	451
	60"	107	122	138	153	171	189	211	231	284	316	364	420	496
	72"	113	129	151	169	187	209	231	249	322	364	413	467	547
	84"	133	151	169	182	200	227	247	273	382	413	444	498	602
	96"	140	160	180	200	222	244	273	296	413	451	480	547	671
	108"	149	169	189	211	236	258	287	311	440	500	547	593	731
120"	156	180	207	231	249	278	304	333	471	536	587	638	791	

Price Chart 2		▶ Boucle (72")			▶ Moire (72")			▶ Net 3000 (118" RR)			▶ No-Lite Fiberglass Duplex (72" RR)							
WINDOW SHADES		▶ Nordicscreen Plus BW 3% / 5% (118")			▶ Nordicscreen Plus Twill 3% (118")			▶ Scala Blackout (110")										
		▶ Serene (98")			▶ SheerWeave 1000 (96")			▶ Solar Screen 3000 1% / 3% (118")										
WIDTH TO:		30"	36"	42"	48"	54"	60"	66"	72"	78"	84"	96"	108"	120"	132"	144"	156"	174"
WINDOW HEIGHT TO:	36"	\$107	118	129	151	171	182	193	207	269	307	342	398	456	516	587	660	753
	48"	111	127	149	164	187	207	227	240	302	329	369	440	507	573	656	744	844
	60"	129	142	164	178	220	231	242	253	327	356	407	467	556	611	680	749	849
	72"	131	153	176	191	238	249	262	280	371	407	464	516	611	673	742	809	918
	84"	153	171	189	213	253	273	287	300	440	464	498	544	673	740	820	898	1013
	96"	169	191	222	242	284	302	320	329	476	507	540	600	747	782	867	933	1040
	108"	180	204	233	256	307	347	351	356	507	560	613	649	813	858	913	984	1093
120"	187	211	240	269	320	360	364	369	522	576	631	676	844	920	956	1031	1144	

Cassette, Fascia and Lift System Surcharges (add to standard rectangular price)

	WIDTH TO:	30"	36"	42"	48"	54"	60"	66"	72"	78"	84"	96"	108"	120"	132"	144"	156"	174"
Small Cassette		\$47	53	58	67	73	80	89	96	100	107	120						
Large Cassette		64	76	84	98	107	116	127	136	149	158	178	196	218				
Mixed Metals Designer Accents-Cassette		49	58	62	67	71	76	80	89	93	98	104	111	116				
Sure Lift Version 2.0		107	113	118	127	133	140	149	156	160	167							
EZ Pull Switch		107	113	118	122	127	131	138	149	158	164							
EZ Lift Cordless		98	102	107	113	116	120	124	129									
Top Down		27	31	33	36	38	53	58	60	62	64							
Season-View		33	36	38	40	42	44	47	49	51	53	58	60	62	64	67	69	71
3" Flat Fascia *		31	36	38	40	44	47	49	53	56	58	64						
4" Flat Fascia *		47	51	56	60	67	73	78	82	89	93	102	111	120				
5" Flat Front Fascia (Single or Dual)		120	129	136	149	156	164	171	178	187	193	213	229	244	262	280	296	322
5" Flat Front & Back Fascia		136	153	167	180	193	211	224	238	251	267	293	322	351	380	407	438	476
Mixed Metals Designer Accents-Fascia		62	71	76	82	89	96	100	111	118	122	136	151	169				
Fabric Cover on Fascia Front		13	16	18	18	20	20	22	22	24	24	27	31	36	40	44	49	51
5" Contract Pocket		160	176	193	213	231	249	267	287	302	322	358	393	429	467	504	538	593
5" Contract Pocket Gravity Lip		22	27	33	36	40	44	49	53	56	60	71	78	89	98	104	113	124
Bd Mtd Shade w/ Fab Wrapped Valance 4 5/8"		111	116	122	129	138	167	182	196	220	244	267						
Bd Mtd Shade w/ Fab Wrapped Valance 7"		120	124	131	138	147	178	196	209	236	262	284						

* For Front Fascia with Back Fascia use price x 2

The value shown in parentheses is the maximum width that a non-railroaded shade can be made. RR indicates railroading available.

Pricing Window Shades

Price Chart 3 WINDOW SHADES		▶ Charmed (110")				▶ Dimensions 3% & 5% (120")				▶ E Screen 3% & 5% (122")								
		▶ Long Bay (110")				▶ Nordicscreen Plus Twill 1% (118")				▶ Opulence (118")								
		▶ Princeton (78")				▶ SheerWeave 2000 (126" RR)				▶ SheerWeave 2390 (126" RR)								
		▶ SheerWeave 3000 (96")				▶ SheerWeave 4100 (98" RR)												
WIDTH TO:		30"	36"	42"	48"	54"	60"	66"	72"	78"	84"	96"	108"	120"	132"	144"	156"	174"
WINDOW HEIGHT TO:	36"	\$113	127	142	160	187	204	222	231	300	344	384	453	516	582	662	749	853
	48"	124	138	158	176	209	231	247	267	338	367	411	500	567	642	736	831	942
	60"	140	158	176	189	240	253	273	284	364	400	451	536	624	687	764	842	956
	72"	153	171	189	213	262	280	296	309	413	453	513	593	676	744	820	893	1016
	84"	167	187	211	236	284	304	316	336	487	518	551	624	709	782	867	944	1067
	96"	193	220	242	267	313	338	356	367	533	562	604	687	798	833	927	998	1111
	108"	207	233	258	287	347	371	391	404	569	620	680	744	864	911	971	1047	1162
120"	233	262	296	322	380	402	422	440	618	669	731	811	909	958	1021	1100	1222	

Price Chart 4 WINDOW SHADES		▶ Duo Vue (98")				▶ Flutter (96")				▶ Garbo (110")				▶ Linen (78")				
		▶ Lux Screen (98")				▶ Mystic (108")				▶ Pearlescent (78" RR)				▶ Rocky Mountain (70")				
		▶ Seto 5000 (110")				▶ Seto 6000 (110")				▶ SheerWeave 2410 (126" RR)				▶ SheerWeave 4400 (126")				
		▶ SheerWeave 5000 (98")				▶ SheerWeave 7450 (118")				▶ Spiral (102")				▶ Triad (118")				
		▶ Yellowstone (72")																
WIDTH TO:		30"	36"	42"	48"	54"	60"	66"	72"	78"	84"	96"	108"	120"	132"	144"	156"	174"
WINDOW HEIGHT TO:	36"	\$131	151	171	187	224	238	251	267	338	398	444	522	596	658	744	824	911
	48"	142	167	187	209	247	269	291	309	371	418	471	576	658	731	831	918	1036
	60"	169	187	209	231	291	307	322	340	416	456	511	622	718	769	867	929	1053
	72"	182	204	231	253	313	338	353	371	458	500	580	689	782	833	929	993	1122
	84"	200	229	253	284	344	364	387	404	540	569	622	729	864	873	958	1040	1182
	96"	233	262	296	322	384	404	422	447	587	620	684	827	964	991	1111	1200	1340
	108"	258	287	316	347	418	444	467	489	627	680	762	900	1042	1084	1171	1264	1400
120"	296	329	362	393	462	487	511	533	678	729	809	984	1107	1193	1289	1391	1542	

Cassette, Fascia and Lift System Surcharges (add to standard rectangular price)

	WIDTH TO:	30"	36"	42"	48"	54"	60"	66"	72"	78"	84"	96"	108"	120"	132"	144"	156"	174"
Small Cassette		\$47	53	58	67	73	80	89	96	100	107	120						
Large Cassette		64	76	84	98	107	116	127	136	149	158	178	196	218				
Mixed Metals Designer Accents-Cassette		49	58	62	67	71	76	80	89	93	98	104	111	116				
Sure Lift Version 2.0		107	113	118	127	133	140	149	156	160	167							
EZ Pull Switch		107	113	118	122	127	131	138	149	158	164							
EZ Lift Cordless		98	102	107	113	116	120	124	129									
Top Down		27	31	33	36	38	53	58	60	62	64							
Season-View		33	36	38	40	42	44	47	49	51	53	58	60	62	64	67	69	71
3" Flat Fascia *		31	36	38	40	44	47	49	53	56	58	64						
4" Flat Fascia *		47	51	56	60	67	73	78	82	89	93	102	111	120				
5" Flat Front Fascia (Single or Dual)		120	129	136	149	156	164	171	178	187	193	213	229	244	262	280	296	322
5" Flat Front & Back Fascia		136	153	167	180	193	211	224	238	251	267	293	322	351	380	407	438	476
Mixed Metals Designer Accents-Fascia		62	71	76	82	89	96	100	111	118	122	136	151	169				
Fabric Cover on Fascia Front		13	16	18	18	20	20	22	22	24	24	27	31	36	40	44	49	51
5" Contract Pocket		160	176	193	213	231	249	267	287	302	322	358	393	429	467	504	538	593
5" Contract Pocket Gravity Lip		22	27	33	36	40	44	49	53	56	60	71	78	89	98	104	113	124
Bd Mtd Shade w/ Fab Wrapped Valance 4 5/8"		111	116	122	129	138	167	182	196	220	244	267						
Bd Mtd Shade w/ Fab Wrapped Valance 7"		120	124	131	138	147	178	196	209	236	262	284						

* For Front Fascia with Back Fascia use price x 2

The value shown in parentheses is the maximum width that a non-railroaded shade can be made. RR indicates railroading available.

Valance, Cornices, Hemline, Tube Upgrade and other Options are on [page 30](#); Motorization is on [pages 32-33](#).

Pricing Window Shades

Price Chart 5 WINDOW SHADES		▶ Adele (110")				▶ Cabos (108")				▶ Cayman (110")				▶ Homespun (79")				
		▶ Keilani (108")				▶ Light-Vue (72" RR)				▶ Loretta (72")				▶ Lucinda (72")				
		▶ Origami (108")				▶ Persia (110")				▶ Petticoat (110")				▶ S Screen Elements (122")				
		▶ S Screen Origins (122")				▶ SheerWeave 2500 (126" RR)				▶ T Screen KOOLBLACK 3% / 5% (122")								
		▶ Tussah (110")																
WIDTH TO:		30"	36"	42"	48"	54"	60"	66"	72"	78"	84"	96"	108"	120"	132"	144"	156"	174"
WINDOW HEIGHT TO:	36"	\$153	173	193	220	251	273	291	307	362	436	482	571	640	707	800	891	984
	48"	167	189	220	242	280	304	333	356	402	456	509	627	713	800	900	991	1120
	60"	193	220	242	267	327	349	369	391	449	489	551	676	776	829	938	1018	1149
	72"	204	236	267	298	356	384	404	427	493	536	624	747	847	900	1004	1082	1220
	84"	227	258	298	333	393	418	444	467	580	613	671	798	933	940	1031	1124	1276
	96"	269	304	342	373	442	467	489	513	631	669	738	900	1056	1084	1211	1311	1460
	108"	300	333	367	404	482	513	540	564	676	733	818	978	1124	1191	1276	1382	1524
120"	330	367	420	449	529	558	584	616	731	778	867	1053	1198	1282	1378	1493	1649	

Warning: When Light-Vue is railroaded the horizontal seam will be significantly darker than the rest of the shade. Light-Vue must be handled with gloves since skin oil is absorbed.

Price Chart 6 WINDOW SHADES		▶ Aedan (79")				▶ Beatty (72")				▶ Berber Slub (72")				▶ Brit (98")				
		▶ Dakota (90")				▶ Dallas (72")				▶ Deco Screen (98")				▶ E Screen KOOLBLACK 3% / 5% (122")				
		▶ Fedora (72")				▶ Grasscloth (72")				▶ Harper (115")				▶ Highland (118")				
		▶ Hombre (72")				▶ Jackson (72")				▶ Lexie (110")				▶ Lizzy (86")				
		▶ Long Bay Blackout (106")				▶ Luminescence (94")				▶ Mystic Eclipse (110")				▶ Palm Beach (118")				
		▶ Reserved (94")				▶ Rollie (79" RR)				▶ Safari (72")				▶ Seclusion (120" RR)				
		▶ Sedona (110")				▶ Shantung (79")				▶ SheerWeave 7400 (118")				▶ Strie (72")				
		▶ SuperWide (106" RR)				▶ Weave (72")				▶ Willow (72")								
WIDTH TO:		30"	36"	42"	48"	54"	60"	66"	72"	78"	84"	96"	108"	120"	132"	144"	156"	174"
WINDOW HEIGHT TO:	36"	\$169	193	227	251	298	313	336	351	416	482	551	638	709	778	887	984	1084
	48"	187	220	249	284	329	356	384	409	462	518	576	700	796	880	991	1102	1231
	60"	211	244	280	311	384	407	424	449	518	569	620	751	862	911	1031	1131	1264
	72"	231	267	307	349	418	447	469	493	569	631	696	831	936	991	1107	1191	1340
	84"	249	296	342	387	462	487	511	533	673	704	744	887	1031	1053	1149	1253	1407
	96"	304	347	393	442	516	542	564	587	731	769	820	1007	1162	1211	1333	1447	1604
	108"	329	373	422	473	569	598	622	649	776	840	907	1084	1251	1296	1427	1549	1718
120"	404	447	487	527	618	638	660	707	842	898	962	1162	1318	1362	1498	1624	1802	

Cassette, Fascia and Lift System Surcharges (add to standard rectangular price)

WIDTH TO:	30"	36"	42"	48"	54"	60"	66"	72"	78"	84"	96"	108"	120"	132"	144"	156"	174"
Small Cassette	\$47	53	58	67	73	80	89	96	100	107	120						
Large Cassette	64	76	84	98	107	116	127	136	149	158	178	196	218				
Mixed Metals Designer Accents-Cassette	49	58	62	67	71	76	80	89	93	98	104	111	116				
Sure Lift Version 2.0	107	113	118	127	133	140	149	156	160	167							
EZ Pull Switch	107	113	118	122	127	131	138	149	158	164							
EZ Lift Cordless	98	102	107	113	116	120	124	129									
Top Down	27	31	33	36	38	53	58	60	62	64							
Season-Vue	33	36	38	40	42	44	47	49	51	53	58	60	62	64	67	69	71
3" Flat Fascia *	31	36	38	40	44	47	49	53	56	58	64						
4" Flat Fascia *	47	51	56	60	67	73	78	82	89	93	102	111	120				
5" Flat Front Fascia (Single or Dual)	120	129	136	149	156	164	171	178	187	193	213	229	244	262	280	296	322
5" Flat Front & Back Fascia	136	153	167	180	193	211	224	238	251	267	293	322	351	380	407	438	476
Mixed Metals Designer Accents-Fascia	62	71	76	82	89	96	100	111	118	122	136	151	169				
Fabric Cover on Fascia Front	13	16	18	18	20	20	22	22	24	24	27	31	36	40	44	49	51
5" Contract Pocket	160	176	193	213	231	249	267	287	302	322	358	393	429	467	504	538	593
5" Contract Pocket Gravity Lip	22	27	33	36	40	44	49	53	56	60	71	78	89	98	104	113	124
Bd Mtd Shade w/ Fab Wrapped Valance 4 5/8"	111	116	122	129	138	167	182	196	220	244	267						
Bd Mtd Shade w/ Fab Wrapped Valance 7"	120	124	131	138	147	178	196	209	236	262	284						

* For Front Fascia with Back Fascia use price x 2

The value shown in parentheses is the maximum width that a non-railroaded shade can be made. RR indicates railroading available.

Pricing Window Shades

Price Chart 7 WINDOW SHADES		▶Boho (94")					▶Kendo(94")					▶Lindley (72")						
		▶SheerWeave 7000 (118" RR)					▶SheerWeave Infinity 2 3% & 5% (98")					▶Spector (84")						
		▶Vista Screen (98")					▶Wave (72")					▶Zootime (86")						
WIDTH TO:		30"	36"	42"	48"	54"	60"	66"	72"	78"	84"	96"	108"	120"	132"	144"	156"	174"
WINDOW HEIGHT TO:	36"	\$193	227	256	293	344	364	384	402	476	551	631	704	782	867	978	1084	1200
	48"	209	249	293	336	387	413	444	471	536	587	671	787	889	991	1113	1238	1382
	60"	244	284	329	369	453	476	498	520	602	638	718	842	964	1031	1160	1269	1420
	72"	262	311	364	416	500	527	553	576	669	718	811	936	1051	1113	1249	1338	1507
	84"	296	349	407	464	529	556	580	629	758	782	867	993	1160	1189	1291	1407	1591
	96"	351	409	469	529	620	642	673	693	811	864	951	1136	1273	1324	1364	1467	1667
	108"	382	444	509	571	687	713	742	767	902	940	1053	1211	1362	1418	1458	1569	1782
120"	476	527	580	633	749	778	811	836	978	1031	1118	1304	1447	1504	1549	1669	1893	

Price Chart 8 WINDOW SHADES		▶Strata (81")					▶Tahiti (70")											
		▶Valencia (94")					▶Vizela (94")											
WIDTH TO:		30"	36"	42"	48"	54"	60"	66"	72"	78"	84"	96"	108"	120"	132"	144"	156"	174"
WINDOW HEIGHT TO:	36"	\$200	238	280	320	362	384	404	422	502	580	671	747	829	911	1036	1140	1264
	48"	224	267	313	364	411	416	449	502	564	627	711	833	949	1056	1189	1318	1471
	60"	256	304	367	427	487	513	536	560	624	689	771	902	1036	1107	1251	1367	1524
	72"	282	338	404	471	540	567	596	620	696	771	873	1004	1131	1196	1336	1433	1616
	84"	313	373	451	527	598	624	653	680	778	842	933	1064	1253	1271	1389	1513	1707
	96"	380	442	516	593	669	693	727	749	844	927	1024						
	108"	407	473	562	651	740	769	802	827	922	1013	1133						
120"	511	564	642	729	809	840	876	902	1007	1107	1202							

Price Chart 9 WINDOW SHADES		▶Pacifica (110")					▶SW Performance + 2390 (96")											
							▶SW Performance + 2410 (96")											
WIDTH TO:		30"	36"	42"	48"	54"	60"	66"	72"	78"	84"	96"	108"	120"	132"	144"	156"	174"
WINDOW HEIGHT TO:	36"	\$258	320	384	447	509	553	598	638	680	804	933	1040	1140	1256	1422	1567	1738
	48"	291	360	436	507	578	622	669	709	758	876	991	1107	1304	1449	1627	1807	2024
	60"	327	411	502	596	682	729	769	816	851	967	1084	1209	1420	1522	1713	1873	2096
	72"	351	453	556	658	758	811	864	911	973	1100	1224	1373	1549	1638	1838	1969	2220
	84"	402	511	620	731	833	893	956	1016	1067	1191	1311	1464	1722	1747	1907	2076	2342
	96"	493	602	713	829	940	996	1053	1111	1164	1302	1433						
	108"	516	642	776	909	1049	1107	1167	1227	1278	1438	1591						
120"	640	767	893	1024	1149	1211	1276	1340	1402	1544	1687							

Cassette, Fascia and Lift System Surcharges (add to standard rectangular price)

	30"	36"	42"	48"	54"	60"	66"	72"	78"	84"	96"	108"	120"	132"	144"	156"	174"
Small Cassette	\$47	53	58	67	73	80	89	96	100	107	120						
Large Cassette	64	76	84	98	107	116	127	136	149	158	178	196	218				
Mixed Metals Designer Accents-Cassette	49	58	62	67	71	76	80	89	93	98	104	111	116				
Sure Lift Version 2.0	107	113	118	127	133	140	149	156	160	167							
EZ Pull Switch	107	113	118	122	127	131	138	149	158	164							
EZ Lift Cordless	98	102	107	113	116	120	124	129									
Top Down	27	31	33	36	38	53	58	60	62	64							
Season-Vue	33	36	38	40	42	44	47	49	51	53	58	60	62	64	67	69	71
3" Flat Fascia *	31	36	38	40	44	47	49	53	56	58	64						
4" Flat Fascia *	47	51	56	60	67	73	78	82	89	93	102	111	120				
5" Flat Front Fascia (Single or Dual)	120	129	136	149	156	164	171	178	187	193	213	229	244	262	280	296	322
5" Flat Front & Back Fascia	136	153	167	180	193	211	224	238	251	267	293	322	351	380	407	438	476
Mixed Metals Designer Accents-Fascia	62	71	76	82	89	96	100	111	118	122	136	151	169				
Fabric Cover on Fascia Front	13	16	18	18	20	20	22	22	24	24	27	31	36	40	44	49	51
5" Contract Pocket	160	176	193	213	231	249	267	287	302	322	358	393	429	467	504	538	593
5" Contract Pocket Gravity Lip	22	27	33	36	40	44	49	53	56	60	71	78	89	98	104	113	124
Bd Mtd Shade w/ Fab Wrapped Valance 4 5/8"	111	116	122	129	138	167	182	196	220	244	267						
Bd Mtd Shade w/ Fab Wrapped Valance 7"	120	124	131	138	147	178	196	209	236	262	284						

* For Front Fascia with Back Fascia use price x 2

The value shown in parentheses is the maximum width that a non-railroaded shade can be made. RR indicates railroading available.

Pricing

Window Shades Options & Surcharges

Valance and Cornice **Surcharges** (add to standard rectangular price)

WIDTH TO:	30"	36"	42"	48"	54"	60"	66"	72"	78"	84"	96"	108"	120"	132"
Price Charts 1 to 4: Top & Bottom Rod Valance	\$107	116	124	136	171	187	207	227	240	258	278			
Price Charts 5 to 9: Top & Bottom Rod Valance	118	131	151	164	213	236	253	278	298	316	340			
Price Charts 1 to 4: 4" or 7" Fabric Cornice	211	224	236	247	284	309	338	360	411	464	511			
Price Charts 5 to 9: 4" or 7" Fabric Cornice	227	244	267	287	327	351	373	400	467	522	582			
Channel Panel Valance	42	44	47	49	51	53	58	60	62	64				
Majesty, Noble 4 5/8" or Camelot Wood Valance	93	100	111	120	140	153	164	173	184	196	229	256	284	304
Stand Alone Fabric Wrapped Valance - 4 5/8"	111	116	122	129	138	167	182	196	220	244	267			
Stand Alone Fabric Wrapped Valance - 7"	120	124	131	138	147	178	196	209	236	262	284			

For Fabric Cornices: 3 1/2" projection standard; 5 1/2" projection no charge; Other projections can be requested for a \$71 per cornice surcharge.

Pricing for a Fabric Wrapped Valance on a shade is shown in the Cassette, Fascia and Lift System Surcharges.

For more information on Valances and Cornice Options, see [pages 61-64](#).

Hemline **Surcharges** (add to standard rectangular price)

WIDTH TO:	30"	36"	42"	48"	54"	60"	66"	72"	78"	84"	96"	108"	120"	132"	144"	156"	174"
Wood Bottom Hem	\$47	49	51	53	58	60	64	71									
Decorative Hem - Gimp/Contrast	49	51	58	62	76	78	82	84	91	104	120	127	136	149	160	171	182
Decorative Hem Grommets	58	67	78	82	96	104	113	120	127	136	158	169	180	193	211	224	238
Decorative Hem - Braid	107	122	136	151	180	193	211	227	244	262	304	329	353	373	407	440	467

To price a second row of Decorative Gimp or Braid, add the Decorative Hem surcharge again.

Wood Bottom Hem and Decorative Hems are not available on shades with Wrapped Aluminum Hemline.

Decorative Braids are only available on a straight sewn hemline and are shown in the Genesis sample book.

For more information on Hemline Options, see [page 65](#).

Tube Size Upgrade **Surcharges** (add to standard rectangular price)

WIDTH TO:	30"	36"	42"	48"	54"	60"	66"	72"	78"	84"	96"	108"	120"	132"	144"	156"
1 1/2" Tube Size Upgrade	\$13	16	18	18	20	20	20	22	22	22	24	24				
2" Tube Size Upgrade	20	22	22	24	27	29	29	31	33	36	36	38				
2 1/2" Tube Size Upgrade	42	47	49	51	53	53	58	58	60	62	64	71	71	73		
3 1/4" Tube Size Upgrade	93	98	104	109	120	124	127	131	140	147	162	178	182	196	138	147

When multiple shades in one room necessitate that the roller tube size be changed to the largest tube size within the room, then the Tube Upgrade surcharge is applied to all shades that would normally use a smaller tube size.

Light Blockout System **Surcharge** (add to standard rectangular price)

WIDTH TO:	36"	42"	48"	54"	60"	66"	72"	78"	84"	96"	108"	120"
36"	\$267	284	304	342	367	391	411	442	462	498	529	696
48"	302	320	338	373	398	420	449	469	496	529	567	729
60"	338	356	380	411	440	462	482	511	529	567	604	767
72"	380	391	404	442	467	489	513	536	562	598	631	791
84"	400	416	440	471	498	520	544	569	596	629	662	827
96"	438	456	469	507	527	556	578	602	624	662	700	862
108"	464	482	502	536	562	587	611	636	658	693	733	891
120"	500	518	536	576	598	602	649	669	696	733	767	929

Genesis Arch **Surcharges** - See [page 38](#) for Genesis Roman Arch Surcharges

Pricing

Window Shades Options & Surcharges

Other Options and **Surcharges** (add to standard rectangular price)

Metal Bead Chain	Add \$20 per shade
Magnetic Hold Downs	Add \$20 per shade
Luxe Decorative Clutch (OS wall mount only)	Add \$91 per shade
Satin Nickel Decorative SL Clutch & Bracket Cover	Add \$11.20 per shade
Galaxy 400 Spring Assist Clutch	Add \$142 per shade
2-on-1 for Cassette (Max. width 156")	Price as two separate shades and add \$47
Dual Shade Bracket (IS mount only)	Price as two separate shades and add \$27
Adjustable 3" Fascia Bracket	Add \$4.50 per shade
Adjustable 4" Fascia Bracket	Add \$5.00 per shade
Season-Vue Exterior Cable Guide	Add \$80 per shade
Galaxy Clutch Upgrade	Add \$29 per shade
Palladian Shelf - Finished	\$25.60 per lineal foot
Palladian Shelf - Unfinished	\$21.20 per lineal foot
FR Coating or Antimicrobial Coating	Call for quote

GENESIS WINDOW SHADE DECORATIVE PULLS - PULLS ARE NOT ATTACHED WHEN SHIPPED!!!

Clear Plastic Hem Grip (Standard with sewn in hem on custom shades, Item 1000A-530170)



No Charge

Eyelet (must specify)



No Charge

Eyelet with Rayon Ring Pull with 12" cord (White 1000A-530330 or Ivory 1000A-530315)

No Charge

3" Colonial Tassel with 8" cord and Eyelet (White 10000-530095 or Ivory 10000-530097)
If Higbee button is desired, order separately



\$6.30 each

Plastic Higbee Button - Specify color (White 1000A-520010 or Ivory 1000A-520025)



No Charge

Decorative Accents - Braids and Pulls

The Decorative Pulls shown below are photographed in the 2014 Genesis sample book.

Decorative Accents pulls are shipped with a metal knotholder for attachment to the shade hemline.

Specify knotholder color: Brushed Aluminum (60-1185-065) or Antique Brass (60-1185-042).

Carpet decorative pull (1 7/8" Diameter) - Slate (1178-800), Wax (1178-900)



\$48.30 each

Charleston decorative pull (1 1/2" Diameter) - Taffeta (3112-799), Mink (3112-216)



\$45.80 each

Leather decorative pull (1" Diameter, 2 1/2" Tall) - Black (4212-048), Brown (4212-128), Cream (4212-235)



\$108.30 each

**ALL PULLS ARE SHIPPED SEPARATELY TO AVOID SHIPPING DAMAGE.
ALL PULLS ARE DESIGNED FOR SEWN HEMLINE WITH A WOOD SLAT.**

Pricing Motorization Surcharges

System II Motorization Surcharges (add to standard rectangular price)		Surcharge
System II Radio Frequency 12V Motor Assembly (Reloadable Battery Wand, Lithium Batteries, Mounting Clips)		\$ 445
System II Radio Frequency 12V Motor Assembly (RF Receiver, Mounting Clips, Solar Pack)		\$578
System II Radio Frequency 12V Motor Assembly (Transformer)		\$ 492
System II Motor Only		\$ 294

Sonesse 30 Wirefree Motorization Surcharges (add to standard rectangular price)		Surcharge
Sonesse 30 Wirefree Motor		\$ 312
Charger for Sonesse 30 Wirefree		29
96" Extension Cable for Sonesse 30 Wirefree Charger		9

Somfy Controls and Accessories Surcharges (add to motorized shade price)		
	Item#	Surcharge
Single Channel Telis RF Transmitter (White), per transmitter	1810632	\$ 100
Single Channel Telis RF Transmitter (Black,Silver), per transmitter	1810639 (Silver), 1810650 (Black)	156
Five Channel Telis RF Transmitter (White), per transmitter	1810633	129
Five Channel Telis RF Transmitter (Black,Silver), per transmitter	1810641 (Silver), 1810652 (Black)	187
Sixteen Channel Telis RF Transmitter (White), per transmitter	1811081	478
Sixteen Channel Telis RF Transmitter (Silver), per transmitter	1811082	507
Single Channel Decoflex Wall Switch (White, Ivory)	1810897 (White), 1810898 (Ivory)	247
Single Channel Decoflex Wall Switch (Black)	1810899	298
Five Channel Decoflex Wall Switch (White, Ivory)	1810813 (White), 1810814 (Ivory)	256
Five Channel Decoflex Wall Switch (Black)	1810830	305
RTS Repeater	1810791	389
Charger Kit - Plug In for Solar Pack	9015781	124
24" Extension Cable for Solar Pack	9016374	16
4' Extension Wire for Battery Pack	9016736	23
8' Extension Wire for Battery Pack	9018624	25
myLink	1811264	404

Somfy Motorization Systems are available for Genesis Window Shades and Roman Shades

Pricing Motorization Surcharges

EZ Charge Lithium Rechargeable Motorization Surcharges (add to standard rectangular price)		Item#	Surcharge
EZ Charge Rechargeable Motorization Version 2.0 Motor			\$ 285
EZ Charge Rechargeable Motorization X2 Motor			367
EZ Charge Rechargeable Motorization X3 Motor (not available on Flat Roman Shades)			478
Charger - One Charger required per order - sold separately	MTDCB-CHARGE		40
15 Channel Remote Control - One Remote required per order - sold separately	MTRF-REM-15NL		89
5 Channel Surface Mount Switch - sold separately	MTRF-WS5-FLUSH		69
Pulse App Interface - ARC Wifi to 433 - 2 way RF Bridge Kit - sold separately	MTRF-WIFIBRD		338
ARC Repeater - sold separately	MT02-0401-05		149
Solar Panel - sold separately	MTSOLPAN-B		109
DC Battery Motor Cable Extender 48" - sold separately	MTDCB-CBLXT48		14
DC Battery Motor Cable Extender 96" - sold separately	MTDCB-CBLXT96		18
Serial Con Kit - sold separately	MTSER-BASE-KIT		152
Sun Sensor - sold separately	MTRF-SUNSENS		56

EZ Charge Motorization Systems are available for Genesis Window Shades and Roman Shades
See pages 14-20 for Genesis Window Shade size specifications.
See page 24 for Genesis Roman Shade size specifications.

Auto-Wand Motorization Surcharge (add to standard rectangular price)		Item#	Surcharge
Auto-Wand Battery Operated Wand Control Motorization Version 2.0 Motor			\$160
6' Micro USB Charger - sold separately	MTPS-USBCABLE		20

Auto-Wand Motorization Systems are available for Genesis Window Shades and Roman Shades

QMotion Motorization Surcharges (add to standard rectangular price)														
	WIDTH TO:	36"	48"	60"	72"	84"	118"	144"						
QMotion Motor - Genesis Window Shades		\$ 727	749	772	794	843	865	1145						
Fascia or Valance Surcharges		WIDTH TO:	36"	42"	48"	54"	60"	66"	72"	78"	84"	96"	118"	144"
QMotion Flat Fascia			\$60	67	71	78	84	89	96	102	107	122	144	173
QMotion Fabric Covered Fascia			82	93	98	102	111	122	131	140	153	169	198	220

Controls and Accessories	Item#	Surcharge
Remote QDR (Gen3) Multi-Channel	IN9500425	\$83
Remote QDR (Gen3) Single Channel	IN9500427	83
Qrelay	IN9500423	100
Qsync (Gen3)	IN9500422+IN6500044	378
QDR Remote Wall Plate	IN9500224	7

Qmotion motorization is available for Genesis Window Shades only

Pricing Shade Masterpieces

Select MP Price Group 5

WIDTH TO:		35"	53"	71"	96"
WINDOW HEIGHT TO:	36"	\$217	280	343	399
	48"	247	310	390	455
	60"	271	338	420	483
	72"	299	380	474	
	84"	338	418	523	
	96"	390	476	597	
	108"	436	532	667	
	120"	490	597	751	

Select MP Price Group 6

WIDTH TO:		35"	53"	71"	96"
WINDOW HEIGHT TO:	36"	\$224	287	355	411
	48"	254	317	404	469
	60"	278	345	436	499
	72"	310	392	495	
	84"	350	429	546	
	96"	404	490	625	
	108"	453	548	700	
	120"	506	614	784	

Select MP Price Group 7

WIDTH TO:		35"	53"	71"	96"
WINDOW HEIGHT TO:	36"	\$229	292	364	420
	48"	261	324	418	483
	60"	287	355	455	518
	72"	320	401	516	
	84"	362	441	569	
	96"	418	504	653	
	108"	469	565	730	
	120"	525	632	819	

Select MP Price Group 8

WIDTH TO:		35"	53"	71"	96"
WINDOW HEIGHT TO:	36"	\$233	296	376	432
	48"	268	331	429	495
	60"	296	364	471	534
	72"	331	413	537	
	84"	376	455	595	
	96"	429	516	679	
	108"	483	579	761	
	120"	541	649	854	

Select MP Price Group 9

WIDTH TO:		35"	53"	71"	96"
WINDOW HEIGHT TO:	36"	\$238	301	385	441
	48"	275	338	443	509
	60"	303	371	488	551
	72"	341	422	558	
	84"	387	467	618	
	96"	443	530	707	
	108"	499	595	791	
	120"	558	665	887	

Select MP Price Group 10

WIDTH TO:		35"	53"	71"	96"
WINDOW HEIGHT TO:	36"	\$243	306	394	450
	48"	282	345	457	523
	60"	313	380	506	569
	72"	350	432	576	
	84"	399	478	642	
	96"	457	544	735	
	108"	513	609	821	
	120"	576	684	922	

Select MP Price Group 11

WIDTH TO:		35"	53"	71"	96"
WINDOW HEIGHT TO:	36"	\$250	313	406	462
	48"	289	352	471	537
	60"	322	390	523	586
	72"	362	443	597	
	84"	411	490	665	
	96"	471	558	763	
	108"	530	625	854	
	120"	593	700	957	

Select MP Price Group 12

WIDTH TO:		35"	53"	71"	96"
WINDOW HEIGHT TO:	36"	\$254	317	415	471
	48"	296	359	485	551
	60"	329	397	539	602
	72"	371	453	618	
	84"	422	502	691	
	96"	485	572	789	
	108"	546	642	884	
	120"	609	716	989	

Select MP Price Group 13

WIDTH TO:		35"	53"	71"	96"
WINDOW HEIGHT TO:	36"	\$259	322	427	483
	48"	303	366	499	565
	60"	338	406	558	621
	72"	383	464	639	
	84"	434	513	714	
	96"	499	586	817	
	108"	560	656	915	
	120"	628	735	1024	

Select MP Price Group 14

WIDTH TO:		35"	53"	71"	96"
WINDOW HEIGHT TO:	36"	\$266	329	441	497
	48"	313	376	520	586
	60"	352	420	583	646
	72"	397	478	670	
	84"	453	532	749	
	96"	520	607	859	
	108"	583	679	961	
	120"	653	761	1076	

Select MP Price Group 15

WIDTH TO:		35"	53"	71"	96"
WINDOW HEIGHT TO:	36"	\$278	341	462	518
	48"	327	390	546	611
	60"	369	436	616	679
	72"	418	499	712	
	84"	476	555	798	
	96"	546	632	912	
	108"	614	709	1022	
	120"	686	793	1143	

Select MP Price Group 16

WIDTH TO:		35"	53"	71"	96"
WINDOW HEIGHT TO:	36"	\$287	350	483	539
	48"	341	404	574	639
	60"	385	453	651	714
	72"	439	520	751	
	84"	499	579	845	
	96"	574	660	968	
	108"	646	742	1085	
	120"	721	828	1213	

Pricing Shade Masterpieces

Select MP Price Group 17

WIDTH TO:		35"	53"	71"	96"
WINDOW HEIGHT TO:	36"	\$301	364	509	565
	48"	357	420	609	674
	60"	406	474	693	756
	72"	464	546	803	
	84"	530	609	905	
	96"	609	695	1036	
	108"	684	779	1162	
	120"	763	870	1297	

Select MP Price Group 18

WIDTH TO:		35"	53"	71"	96"
WINDOW HEIGHT TO:	36"	\$320	383	548	604
	48"	385	448	663	728
	60"	441	509	763	826
	72"	504	586	884	
	84"	579	658	1001	
	96"	663	749	1146	
	108"	744	840	1283	
	120"	833	940	1435	

Select MP Price Group 19

WIDTH TO:		35"	53"	71"	96"
WINDOW HEIGHT TO:	36"	\$345	408	600	656
	48"	418	481	730	796
	60"	483	551	847	910
	72"	555	637	987	
	84"	637	716	1120	
	96"	730	817	1281	
	108"	821	917	1437	
	120"	917	1024	1605	

Select MP Price Group 20

WIDTH TO:		35"	53"	71"	96"
WINDOW HEIGHT TO:	36"	\$371	434	651	707
	48"	453	516	800	866
	60"	527	595	933	996
	72"	607	688	1090	
	84"	698	777	1241	
	96"	800	887	1419	
	108"	898	994	1591	
	120"	1003	1111	1778	

COM Window Shades

WIDTH TO:		35"	53"	71"	96"
WINDOW HEIGHT TO:	36"	\$193	256	293	349
	48"	213	276	320	387
	60"	227	296	336	398
	72"	249	331	371	
	84"	278	358	402	
	96"	320	407	460	

Cassette and Fascia Surcharges (add to std rectangular price)

WIDTH TO:		30"	36"	42"	48"	54"	60"	66"	72"	78"	84"	96"
Large Cassette (Max. height 84")		\$64	76	84	98	107	116	127	136	149	158	178
4" Flat Fascia (Max. height 96")		47	51	56	60	67	73	78	82	89	93	102

Hemline Surcharges (add to standard rectangular price)

WIDTH TO:		30"	36"	42"	48"	54"	60"	66"	72"	78"	84"	96"
Wood Bottom Hem		\$47	49	51	53	58	60	64	71			
Decorative Hem - Gimp/Contrast		49	51	58	62	76	78	82	84	91	104	120
Decorative Hem - Grommets		58	67	78	82	96	104	113	120	127	136	158

To price a second row of Decorative Gimp, add the Decorative Hem surcharge again.

Tube Upgrade Surcharges (add to standard rectangular price)

WIDTH TO:		30"	36"	42"	48"	54"	60"	66"	72"	78"	84"	96"
1 1/2" Tube Size Upgrade		\$13	16	18	18	20	20	20	22	22	22	24
2" Tube Size Upgrade		20	22	22	24	27	29	29	31	33	36	36
2 1/2" Tube Size Upgrade		42	47	49	51	53	53	58	58	60	62	64
3 1/4" Tube Size Upgrade		93	98	104	109	120	124	127	131	140	147	162

Pricing Flat Roman Shades

There are no fabrics in Price Chart 1

Price Chart 2 FLAT ROMAN		► Net 3000 (98")		► SheerWeave 1000 (96")		
WIDTH TO:		36"	54"	78"	84"	98"
FINISHED LENGTH	48" Flat	\$304	438	531	624	689
	60" Flat	347	507	620	709	776
	72" Flat	436	620	771	907	996
	84" Flat	480	689	864	1007	1102
	96" Flat	536	769	956	1120	1227
	108" Flat	582	840	1047	1229	1351
	120" Flat	627	918	1138	1331	1462

Price Chart 3 FLAT ROMAN		► Charmed (98")		► Dimensions 3% & 5% (98")		
WIDTH TO:		36"	54"	78"	84"	98"
FINISHED LENGTH	48" Flat	\$322	458	567	667	738
	60" Flat	380	540	667	762	831
	72" Flat	456	653	824	971	1064
	84" Flat	509	736	924	1082	1178
	96" Flat	558	809	1024	1202	1318
	108" Flat	609	878	1122	1322	1453
	120" Flat	660	956	1220	1433	1569

Price Chart 4 FLAT ROMAN		► Flutter (96")		► Garbo (98")		
WIDTH TO:		36"	54"	78"	84"	98"
FINISHED LENGTH	48" Flat	\$349	511	640	751	827
	60" Flat	407	584	751	867	956
	72" Flat	509	700	942	1100	1211
	84" Flat	567	787	1047	1213	1333
	96" Flat	620	862	1160	1364	1493
	108" Flat	680	942	1267	1493	1651
	120" Flat	742	1016	1387	1620	1791
Yellowstone Flat Lining		140	182	207	N/A	N/A

Pricing Flat Roman Shades

Price Chart 5 FLAT ROMAN		▶ Adele (98")		▶ Cabos (98")		▶ Cayman (98")		
		▶ Homespun (79")		▶ Keilani (98")		▶ Loretta (72")		
		▶ Origami (98")		▶ Persia (98")		▶ SheerWeave 2500 (98")		
		▶ T Screen KOOLBLACK 3% / 5% (98")						
		WIDTH TO:		36"	54"	78"	84"	98"
FINISHED LENGTH	48" Flat	5380	560	696	773	862		
	60" Flat	436	667	818	887	984		
	72" Flat	536	811	1020	1138	1262		
	84" Flat	600	918	1122	1253	1387		
	96" Flat	649	1000	1280	1393	1549		
	108" Flat	711	1060	1420	1533	1702		
	120" Flat	767	1196	1442	1662	1847		

Price Chart 6 FLAT ROMAN		▶ Beatty (72")		▶ Berber Slub (72")		▶ Dakota (90")		
		▶ Dallas (72")		▶ E Screen KOOLBLACK (98")		▶ Fedora (72")		
		▶ Grasscloth(72")		▶ Hombre (72")		▶ Jackson (72")		
		▶ Lizzy (86")		▶ Shantung (79")		▶ Strie (72")		
		▶ Willow (72")						
		WIDTH TO:		36"	54"	78"	84"	98"
FINISHED LENGTH	48" Flat	5389	569	700	816	902		
	60" Flat	440	669	820	947	1040		
	72" Flat	544	813	1024	1196	1316		
	84" Flat	609	920	1178	1322	1458		
	96" Flat	660	1038	1313	1476	1622		
	108" Flat	724	1142	1444	1622	1787		
	120" Flat	771	1198	1496	1747	1922		

Price Chart 7 FLAT ROMAN		▶ Boho (94")		▶ Kendo (94")				
		▶ Vista Screen (98")						
		WIDTH TO:		36"	54"	78"	84"	98"
FINISHED LENGTH	48" Flat	5402	622	756	820	911		
	60" Flat	467	738	856	984	1047		
	72" Flat	571	891	1102	1231	1367		
	84" Flat	633	993	1220	1384	1524		
	96" Flat	702	1098	1338	1522	1662		
	108" Flat	773	1218	1467	1684	1869		
	120" Flat	844	1324	1551	1782	1960		

Price Chart 8 FLAT ROMAN		▶ Tahiti (70")		▶ Vizela (94")				
		WIDTH TO:		36"	54"	78"	84"	94"
FINISHED LENGTH	48" Flat	5409	636	771	889	976		
	60" Flat	478	751	876	1020	1122		
	72" Flat	584	911	1133	1269	1393		
	84" Flat	651	1020	1258	1444	1593		
	96" Flat	727	1124	1376	1567	1724		
	108" Flat	798	1253	1496	1744	1927		
	120" Flat	867	1356	1596	1813	1996		
Tahiti Flat Lining		140	182	207	N/A	N/A		

Pricing

Flat Roman Shades Options & Surcharges

Roman Shade Width Based Surcharges (add to standard rectangular price)					
WIDTH TO:	36"	54"	78"	84"	98"
Quick Lift or Traditional Clutch System	No Charge - Quick Lift Clutch Recommended				
Top Down/Bottom Up	\$82	122	129	140	158
Extra 6" Valance Height	36	42	47	51	64
Gimp on Bottom of Shade or Valance	64	91	122	129	151

CareRING Cordless Surcharge (add to standard rectangular price)							
WIDTH TO:	30"	36"	42"	48"	60"	72"	78"
	\$67	71	76	80	89	105	111

Roman Shade Design Options and Surcharges (add to shade price)	
Bead Chain - Metal	Add \$20 per shade
2-on-1 Headrail	Add \$69 to separate shade prices
3-on-1 Headrail	Add \$96 to separate shade prices
Solid Banding-Dakota, Tahiti & Yellowstone-2 Edges	Add \$189
Solid Banding-Dakota, Tahiti & Yellowstone-3 or 4 Edges	Add \$247
Angle Top / Arch Top Shade	Add \$280
Palladian Shelf - Finished	\$25.60 per lineal foot
Palladian Shelf - Unfinished	\$21.20 per lineal foot
FR Coating or Antimicrobial Coating	Call for quote

Roman Arch or Angle Surcharges (add to price at highest height and widest width)			
Standard Arch or Angle	\$147		
WIDTH TO:	36"	48"	60"
Framed Arch or Angle	\$516	602	687
Routed Framed Arch or Angle	707	791	876

Flat Roman Shade Motorization Surcharges

Somfy System II - See [pages 44-45](#)

Sonnesse 30 Wirefree - See [pages 44-45](#)

EZ Charge Version 2.0 - See [pages 46-47](#)

EZ Charge X2 - See [pages 46-47](#)

QMotion and EZ Charge X3 are not available on Flat Roman Shades

Pricing Panel Track Shades

For Panel Track, wand control option is available to 96" length;
cord control option is available to 144" length

CHART 1	PANEL TRACK	▶Fiber-Lucent ▶Princeton				▶Net 3000 ▶Solar Screen 1% / 3%				▶Nordicscreen Plus BW 5%				
		WIDTH	48"	60"	72"	84"	96"	108"	120"	132"	144"	156"	168"	180"
HEIGHT	48"	\$316	367	411	464	500	700	751	818	869	1033	1098	1156	1220
	60"	329	387	436	487	531	742	793	864	920	1089	1156	1218	1284
	72"	349	411	464	518	567	776	833	904	960	1142	1213	1276	1353
	84"	369	427	482	540	598	816	880	947	1013	1198	1273	1333	1413
	96"	387	449	509	576	633	856	922	996	1060	1253	1327	1402	1480
	108"	404	471	531	600	669	887	958	1040	1111	1304	1387	1464	1544
	120"	422	493	562	633	689	929	998	1087	1158	1362	1447	1520	1616
	144"	462	533	609	684	758	1004	1087	1176	1260	1464	1562	1642	1738

CHART 2	PANEL TRACK	▶Charmed ▶Long Bay ▶Opulence ▶SheerWeave 3000				▶Dimensions 3% / 5% ▶Nordicscreen Plus BW 3% ▶SheerWeave 2000 ▶SheerWeave 4100				▶Garbo ▶Nordicscreen Plus Twill 1% / 3% ▶SheerWeave 2390 ▶Triad				
		WIDTH	48"	60"	72"	84"	96"	108"	120"	132"	144"	156"	168"	180"
HEIGHT	48"	\$367	422	478	536	596	804	873	944	1004	1187	1264	1333	1407
	60"	391	456	520	582	640	867	933	1009	1082	1271	1349	1427	1509
	72"	418	489	556	624	689	927	1000	1082	1158	1351	1444	1522	1607
	84"	449	529	598	671	740	987	1062	1151	1231	1440	1533	1618	1709
	96"	473	558	631	711	796	1047	1131	1222	1309	1524	1620	1711	1809
	108"	502	596	678	760	840	1104	1193	1293	1387	1607	1711	1804	1913
	120"	531	624	709	804	891	1162	1260	1362	1458	1691	1802	1904	2011
	144"	584	687	793	893	996	1278	1387	1507	1609	1860	1980	2098	2218

CHART 3	PANEL TRACK	▶Duo Vue ▶Persia ▶SheerWeave 5000				▶Lux Screen ▶SheerWeave 2410 ▶SheerWeave 7450				▶Mystic ▶SheerWeave 4400 ▶Spiral				
		WIDTH	48"	60"	72"	84"	96"	108"	120"	132"	144"	156"	168"	180"
HEIGHT	48"	\$393	462	529	596	651	878	949	1027	1100	1284	1369	1444	1529
	60"	436	507	576	649	711	956	1029	1113	1193	1393	1487	1567	1658
	72"	469	544	622	700	776	1029	1111	1202	1284	1507	1598	1689	1787
	84"	502	587	678	758	844	1104	1193	1293	1387	1609	1711	1809	1913
	96"	536	631	727	816	904	1178	1276	1382	1482	1711	1829	1924	2044
	108"	571	678	764	876	964	1249	1351	1469	1580	1818	1944	2053	2173
	120"	604	711	816	929	1031	1322	1438	1556	1669	1924	2056	2173	2304
	144"	678	800	918	1047	1160	1471	1598	1738	1864	2140	2280	2422	2556

Valance Surcharges		(add to Panel Track price)												
WIDTH	48"	60"	72"	84"	96"	108"	120"	132"	144"	156"	168"	180"	192"	
Artisan Valance	\$47	58	67	76	84	93	102	111	120					
Majesty, Noble or Camelot Wood Valance	124	149	178	196	229	251	282	307	389	418	458	482	507	

A Window Shade Cornice is available for Panel Track.

Price the Genesis Window Shade Cornice pricing on [page 30](#) using the Window Shade price group.

Pricing Panel Track Shades

For Panel Track, wand control option is available to 96" length;
cord control option is available to 144" length

CHART 4	PANEL TRACK	▶ Adele				▶ Cayman				▶ Dallas				▶ Deco Screen			
		▶ Fedora				▶ Grasscloth				▶ Hombre				▶ Homespun			
		▶ Loretta				▶ Lucinda				▶ Rocky Mountain				▶ S Screen Elements			
		▶ S Screen Origins				▶ Shantung				▶ SheerWeave 2500				▶ T Screen with KOOLBLACK 3% / 5%			
		▶ Willow				▶ Yellowstone											
WIDTH		48"	60"	72"	84"	96"	108"	120"	132"	144"	156"	168"	180"	192"			
HEIGHT	48"	\$447	520	587	667	738	973	1058	1142	1222	1429	1522	1607	1700			
	60"	487	576	651	740	816	1078	1162	1260	1347	1567	1667	1764	1864			
	72"	533	627	711	809	898	1167	1267	1376	1469	1707	1816	1918	2031			
	84"	578	682	776	887	976	1267	1369	1489	1596	1847	1967	2076	2196			
	96"	622	738	844	956	1062	1362	1478	1602	1718	1978	2113	2233	2364			
	108"	667	793	904	1029	1142	1458	1582	1718	1847	2118	2258	2389	2533			
	120"	709	844	964	1104	1227	1549	1689	1836	1967	2258	2402	2547	2698			
	144"	800	951	1100	1247	1391	1744	1902	2060	2211	2536	2700	2862	3024			

CHART 5	PANEL TRACK	▶ Aedan				▶ Beatty				▶ Berber Slub				▶ Boho			
		▶ Brit				▶ Dakota				▶ Harper				▶ Jackson			
		▶ Lizzy				▶ Long Bay Blackout				▶ Mystic Eclipse				▶ Rollie			
		▶ Sedona				▶ SheerWeave 7000				▶ SheerWeave 7400				▶ Spector			
		▶ Strie				▶ Vista Screen				▶ Wave				▶ Weave			
WIDTH		48"	60"	72"	84"	96"	108"	120"	132"	144"	156"	168"	180"	192"			
HEIGHT	48"	\$598	707	804	918	1024	1311	1420	1544	1656	1911	2038	2153	2273			
	60"	680	802	922	1047	1162	1482	1607	1744	1871	2153	2293	2427	2562			
	72"	756	893	1031	1176	1309	1651	1793	1947	2089	2393	2553	2704	2862			
	84"	833	996	1142	1298	1453	1816	1976	2149	2311	2636	2813	2973	3153			
	96"	907	1084	1256	1429	1596	1980	2164	2347	2527	2882	3071	3249	3442			
	108"	991	1182	1367	1551	1740	2158	2347	2551	2749	3122	3327	3529	3738			
	120"	1064	1278	1478	1687	1887	2322	2536	2753	2964	3364	3589	3802	4031			
	144"	1227	1467	1700	1940	2173	2660	2904	3156	3398	3853	4107	4351	4609			

CHART 6	PANEL TRACK	▶ SheerWeave Infinity 2 3% / 5%				▶ SheerWeave Performance + 2390				▶ Valencia				
		▶ SheerWeave Performance + 2410				▶ Vizela								
WIDTH		48"	60"	72"	84"	96"	108"	120"	132"	144"	156"	168"	180"	192"
HEIGHT	48"	\$756	867	964	1082	1187	1576	1689	1816	1927	2273	2404	2533	2662
	60"	853	976	1102	1229	1347	1771	1904	2044	2176	2556	2707	2847	2989
	72"	956	1102	1231	1376	1511	1973	2118	2271	2424	2833	3009	3156	3316
	84"	1058	1218	1362	1522	1667	2171	2327	2500	2664	3122	3298	3467	3640
	96"	1158	1333	1493	1662	1836	2373	2547	2729	2907	3400	3593	3778	3976
	108"	1260	1449	1624	1813	1998	2560	2758	2964	3153	3680	3891	4089	4291
	120"	1353	1562	1756	1964	2158	2767	2971	3191	3398	3964	4184	4398	4624
	144"	1556	1793	2016	2253	2482	3164	3400	3647	3880	4524	4780	5024	5278

Valance Surcharges		(add to Panel Track price)												
WIDTH	48"	60"	72"	84"	96"	108"	120"	132"	144"	156"	168"	180"	192"	
Artisan Valance	\$47	58	67	76	84	93	102	111	120					
Majesty, Noble or Camelot Wood Valance	124	149	178	196	229	251	282	307	389	418	458	482	507	

A Window Shade Cornice is available for Panel Track.

Price the Genesis Window Shade Cornice pricing on [page 30](#) using the Window Shade price group.

Product Information

Window Shades with Clutch

Product Features - SL Series Standard

- Fits rectangular window openings.
- Operated with continuous bead chain loop.
- Hooked clutch and spring pin-end for easy installation.
- Nylon fiberglass filled construction for quieter performance and added durability.
- Fabric comes off the back of the roller.
- Wrapped metal hem bar.
- Color coordinated continuous bead chain loop, bottom rail and end caps.
- Color coordinated bracket covers for OS mount shades to match clutch color.



SL Series - Inside Mount



SL Series - Outside Mount

Mounting Requirements

• Inside Mount (IS) - Minimum Mounting Depth		
- SL Series	1" Tube	2 5/16"
	2 1/2", 3 1/4" Tube	3"
	All other	2 7/16"
- Small Cassette	All Tubes	1 3/8"
- Large Cassette	All Tubes	1 1/4"
- 3", 4", 5" Fascia	All Tubes	7/8"
• Inside Mount (IS) - Mounting Depth - Flush Mount		
- SL Series	1" Tube	2 5/16"
	2 1/2", 3 1/4" Tube	3 11/16"
	All other	2 3/4"
- Small Cassette	All Tubes	3 5/8"
- Large Cassette	All Tubes	4 7/16"
- 3" Fascia	All Tubes	3 1/8"
- 4" Fascia	All Tubes	4 1/8"
- 5" Fascia	All Tubes	5 1/8"
• Inside Mount (IS) - Min Mounting Depth - Side Mount		
- SL Series	All tubes	3/4"
• Outside Mount (OS) - Minimum Flat Vertical Surface		
- SL Series	All tubes	2 1/4"
- Small /Large Cassette	All Tubes	1" / 1 3/8"
- 3" Fascia / 4" Fascia	All Tubes	1 7/8" / 3 7/8"
- 5" Fascia	All Tubes	4 7/8"

For R Series Mounting Requirements, see [page 67](#).

Finished Dimensions

- Inside Mount (IS)
 - Clutch - SL Series: - 1/8"
 - Clutch - R Series: - 3/16"
 - Small Cassette: - 1/8"
 - Large Cassette: - 1/8"
- Outside Mount (OS)
 - All systems: Ordered width
- Cloth Measure (CM)
 - Clutch - SL Series: + 1 1/8"
 - Clutch - R Series: + 1 3/16"
 - Small Cassette: + 1 1/16"
 - Large Cassette: + 1 1/4"

Size Standards

See Size Standards on [pages 5-8](#).

Important Child Safety Note

In order to comply with the ANSI approved Standard For Safety of Window of Window Covering Products all supplied cord tension/locking devices or cord cleats must be properly installed.

Continuous Bead Chain Drops

Shade Length	Drop	Shade Length	Drop
Up to 22"	12"	54 1/16" - 66"	48"
22 1/16" - 27"	18"	66 1/16" - 78"	60"
27 1/16" - 39"	24"	78 1/16" - 90"	72"
39 1/16" - 42"	36"	90 1/16" - 102"	84"
42 1/16" - 54"	39"	Over 102"	96"

*Note: Custom lengths or lengths longer than 96" will have a connector. See [page 66](#).

Hardware Included

- Installation Brackets
- Cord Tension Lock

Options

- No Charge
 - Bead Chain Drop Substitution (table above)
 - Bottom Hem - Heat Sealed
 - Clutch Color Substitution
 - P Clip Safety Tensioner
 - R Series Clutch Substitution (Vanilla, Black)
 - Reverse Roll - Maximum height 96"
 - Sewn In Hem
- Surcharge
 - 2-on-1 Headrail - Cassette only - Max. width 156"
 - Bead Chain - Metal
 - Board Mounted Shade with Fabric Wrapped Valance - [Page 60](#)
 - Bottom Hem - Decorative or Wood
 - Bracket - Dual Shade - Max. width 103" - Max. height 96", IS only
 - Cassette - Small or Large
 - Clutch - Galaxy 400 Spring Assist Clutch
 - Fascia - 3" Flat, 4" Flat, 5" Flat, 5" Pocket
 - Magnetic Hold Downs
 - Satin Nickel Clutch & Bracket Cover (SL clutch only)
 - Tube Size Upgrade
 - Valances & Cornices - [Pages 61-64](#)



R Series Clutch Roller shown with Reverse Roll

Ordering Notes

- Exclusions: Decorative Pulls not available on wrapped metal hem.
- SL Clutch brackets are universal for inside mount, outside mount, ceiling mount, standard or reverse roll shades.

Caution

- Outside mount reverse roll shades project out at least 1 1/2" from the wall causing a larger light gap. The shade fabric on reverse roll shades does not roll up as tightly as a regular roll shade. Avoid using stiff and heavy fabrics on reverse roll shades.

Product Information

Window Shades with Decorative Clutch Systems

Luxe™ Decorative Clutch

- Fits rectangular window openings.
- Decorative clutch with enhanced internal springs for smoother operation.
- Satin Nickel or Vintage Brass finish.
- Outside Mount only.
- Operated with coordinating continuous metal bead chain loop.
- Brackets are heavy duty cast and machined metal.
- Unique twist pin-end eases installation.
- Fabric comes off the back of the roller.
- Uses 1 1/2" aluminum tube.



Luxe Clutch

Mounting Requirements

- | |
|---|
| • Outside Mount (OS) - Minimum Flat Vertical Surface |
| - Luxe 1 1/2" tube 2 1/4" |

Finished Dimensions

- Outside Mount (OS)
 - All systems: Ordered width
- Cloth Measure (CM)
 - All systems: + 1 3/8"

Size Standards

Maximum Height: 96".
Maximum Width: 103" or fabric width - See [pages 5-8](#).

Important Child Safety Note

In order to comply with the ANSI approved Standard For Safety of Window of Window Covering Products all supplied cord tension/locking devices or cord cleats must be properly installed.

Continuous Bead Chain Drops

Shade Length	Drop	Shade Length	Drop
Up to 22"	12"	54 1/16" - 66"	48"
22 1/16" - 27"	18"	66 1/16" - 78"	60"
27 1/16" - 39"	24"	78 1/16" - 90"	72"
39 1/16" - 42"	36"	90 1/16" - 102"	84"
42 1/16" - 54"	39"	Over 102"	96"

*Note: Custom lengths or lengths longer than 96" will have a connector. See [page 66](#).

Hardware Included

- Installation Brackets
- Cord Tension Lock

Options

- No Charge
 - Bead Chain Drop Substitution (table above)
 - Bottom Hem - Heat Sealed
 - P Clip Safety Tensioner
 - Reverse Roll
 - Sewn In Hem
- Surcharge
 - Bottom Hem - Decorative
 - Bottom Hem - Wood
 - Magnetic Hold Downs
 - Valances & Cornices - [Pages 61-64](#)

Ordering Notes

- Exclusions: Decorative Pulls not available on wrapped metal hem; Motorization.

Caution

- Outside mount reverse roll shades project out at least 1 1/2" from the wall causing a larger light gap. The shade fabric on reverse roll shades does not roll up as tightly as a regular roll shade. Avoid using stiff and heavy fabrics on reverse roll shades.

Product Information

Auto-Wand Motorization Version 2.0



Auto-Wand Product Features

- Available on Genesis window shades and roman shades.
- Battery operated motor with wand control.
- Economical child safe solution with no cords.
- Up or Down position controlled by button on wand.
- Top and bottom limits can be set.
- Lithium battery is internal and rechargeable.
- Wand is White, Gray or Black. See [pages 82-84](#) for color coordination.
- Wand control is on either side of the shade.
- Rechargeable battery can offer 6 to 12 months on a single charge under normal conditions.
- 5 Year Motor Warranty

Size Standards

- See Size Standards on [pages 13-16](#).
- Maximum Area cannot be exceeded for any shade.
- Minimum width: 22"
- Minimum length: 28"

Options

- Surcharge
 - Board Mounted Shade with Fabric Wrapped Valance
 - Cassette - Small or Large
 - Charger - 6' Cable with Micro USB
 - Mixed Metal Designer Accents on Cassette - [Page 61](#)

Wand Length

Shade Length	Wand
Up to 39"	24"
39 1/16" - 54"	36"
Over 54 1/16"	48"

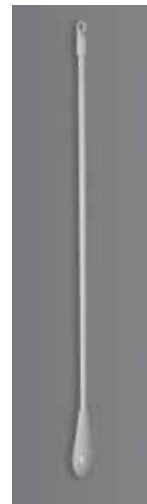

Finished Dimensions

- Inside Mount (IS)
 - All systems: -1/8"
- Outside Mount (OS)
 - All systems: Ordered width
- Cloth Measure (CM):
 - R Series Bracket: + 1 1/4"
 - Small Cassette: + 1 3/16"
 - Large Cassette: + 1 3/16"

Ordering Notes

- Specify Inside or Outside Mount.
- Price as a standard shade, and add the motor surcharge per shade.
- **Exclusions:** Fascia; Season-View shades.

Motorization Services

- Motorization Skill Set offered in Customer Service
 - 800-342-5523
 - motor@lafvb.com
- Technical Support by trained Customer Service Agents
- Assistance in the specification of large motorization applications
- Liason between dealers/designers, electricians and home automation integrators.

Product Information

Somfy Battery Operated Series



Somfy Battery Motorization Features

- Available for Genesis Window Shades and Roman Shades.
- Available for Small and Large Cassette Genesis Window Shades.
- Available for 3" 4" and 5" Fascia Genesis Window Shades.
- Uses an SL Series bracket for Window Shades; R Series bracket is available.
- Maximum sizes for Window Shades: [Pages 13-16](#).
- Maximum sizes for Roman Shades: [Page 24](#).



System II Information (1.1Nm)

- 12V DC Motor
- Available on 1 1/2" tube
- Can be powered via 8AA Lithium batteries, Solar Pack Kit or Transformer
- Minimum width 16"; Maximum width 102"
- Minimum height 24"; Maximum height 120"
- Maximum area 64 square feet.
- Non-adjustable 28 RPM roller speed
- Compatible with all of Somfy's RTS transmitters



System II Motor

Sonesse 30 Wirefree Information (2Nm)

- Built in Lithium-ion rechargeable battery
- Available on 1 1/2" or 2" tube
- 96" Charger Extension Cable available (sold separately)
- Minimum width 29"; Maximum width 120"
- Minimum height 24"; Maximum height 120"
- Maximum area 80 square feet.
- Adjustable speed 10-28 RPM
- Compatible with all of Somfy's RTS transmitters



Sonesse 30 Wirefree Motor

Options

- Surcharge
 - Cassette and Fascia Options
 - Board Mounted Shade with Fabric Wrapped Valance
 - Cassette - Large or Small
 - Fascia - 3" Flat, 4" Flat or 5" Flat
 - Mixed Metal Designer Accents on Cassette or Fascia - [Page 61](#)

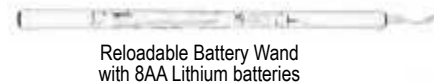

Reloadable Battery Wand with 8AA Lithium batteries



10' Transformer

Additional Power Options for System II Motor

- 12V DC Power Supply (Individual)
- 12V DC Power Supply Distributed Power (Large Applications)
- Solar Pack



Solar Pack Kit with 10 NiMH batteries

Controls

- Remotes
 - ♦ 1 Channel (Black, White, Silver)
 - ♦ 5 Channel (Black, White, Silver)
 - ♦ 16 Channel (White, Silver)
- Wall Switches (Black, White, Ivory)
 - ♦ 1 Channel or 5 Channel



Coming soon - Sonesse 30 Wirefree Solar Panel



5' Charger

Finished Dimensions

- Inside Mount (IS)
 - All Systems: -1/8"
- Outside Mount (OS)
 - All systems: Ordered width
- Cloth Measure (CM):
 - SL Series Bracket: + 1 1/8"
 - R Series Bracket: + 1 3/16"
 - Small Cassette: + 1 1/4"
 - Large Cassette: + 1 1/4"

Ordering Notes

- Specify Inside or Outside Mount.
- Order Transmitter(s) or Wall Switch(s) as required.
- Check for other options required that are available.
- Choose left or right side for power cord and motor.
- Price as a standard shade, add the motor surcharge per shade and other surcharges (transmitters, etc.).
- Specify desired channel(s) for programming.
- **Window length is required** so that the limits can be set
- **Exclusions:** Season-Vue shades.

Product Information

Somfy Battery Operated Series



Somfy myLink Overview

- WiFi to RTS bridge that can control up to 16 channels of RTS motorized products using the Somfy myLink apps for iOS and Android devices.
- Using the app, users can send immediate RTS commands, create Scenes and Schedules.
- Users can access their myLinks from anywhere with the apps' remote access feature.
- Multiple myLinks can be joined within the same system for multi-zone control.
- Can also serve as an IP to RTS bridge for 3rd party control systems.
- Amazon Alexa integration

Features Summary:

- Control for up to 16 RTS channels per myLink from iOS and Android devices.
- Join up to 10 myLinks together for multi-zone control.
- Manually activate RTS products.
- Automate window shades with scenes and schedules.
- Supports Up/Down/My/Stop commands and increments control (tilt/brightness)
- Multiple users
- Remote access
- Integration with third party-systems over IP
- Compatible with Somfy Synergy™ API

Technical Specifications

- 120V AC; 50-60Hz
- Ultra Low Power Wi-Fi (802.11 b/g/n)
- 3.64 L x 2.35W x 1.95 H
- Radio Frequency:
 - RTS 433.42 MHz
 - WiFi: 2.4 GHz and 5 GHz
- iOS Version: 7 and higher
- Android Version: Jelly Bean and higher
- FCC ID: DWMNYLINK
- Operating Temp 41° F to 113° F
- Rated Current (Amps): 10 to 50 milliamps
- Insulation Class: Class II
- For Indoor Use Only
- Enclosure:
 - PE
 - UL94V-0 flame rating
 - RoHS compliant
 - UL listed
- Shipping Weight: 1 lb.

Motorization Services

- Customer Service Motorization Skill Set
 - 800-342-5523
 - motor@lafvb.com
- Technical Support by trained Customer Service Agents
- Assistance in the specification of motorization applications
- Liason between dealers/designers, electricians and home automation integrators.

Connections and Indicators:



- | | |
|-----------------|---|
| 1. Setup Button | Engages setup mode |
| 2. Status LED | <p>Solid Red: The myLink is ready to accept WiFi network information or have its PIN changed. This is the mode the myLink should be in out of the box.</p> <p>Solid Green: myLink is successfully connected to WiFi network</p> <p>Slow Blinking Green: searching for/connecting to a WiFi network/is disconnected from its know WiFi network</p> <p>Single Orange Blink: myLink is sending RTS commands</p> <p>Solid Orange: Firmware update mode</p> <p>Slow Blinking Red: myLink is scanning both 2.4GHz and 5GHz bands for nearby WiFi networks</p> |
| 3. AC Prongs | AC prongs |

Wiring Best Practice:

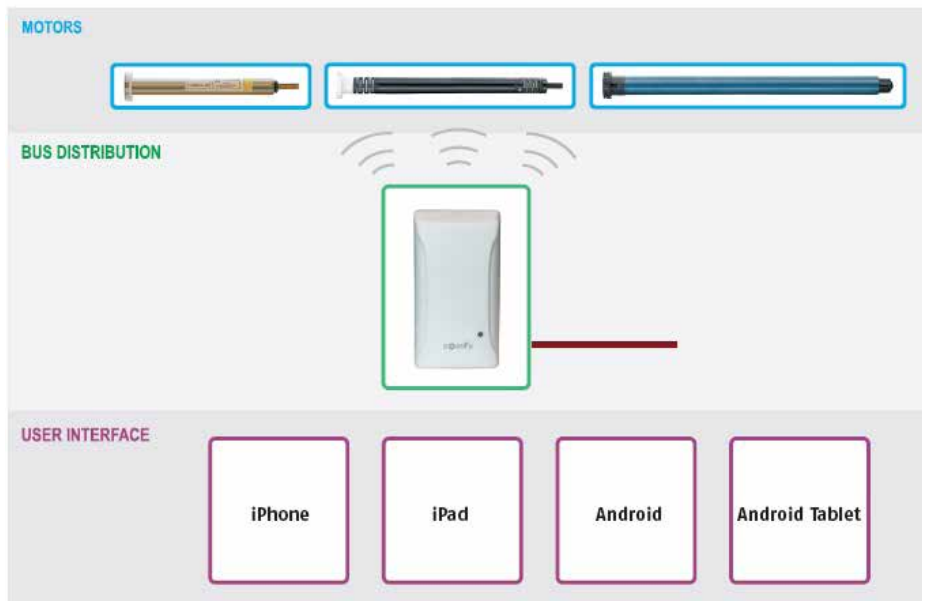

Product Information

EZ Charge™ Lithium Rechargeable Series



EZ Charge Product Features

- Available on Genesis window shades and roman shades.
- Battery powered motor with remote control or wall switch or app interface (all purchased separately).
- Lithium-ion battery is internal and rechargeable.
- Remote offers up to 15 channels separately or in groups.
- Electronic stop setting.
- Rechargeable battery can offer 6 to 12 months on a single charge under normal conditions. Charger has a 12' cord sold separately. Extension cables sold separately.
- 6 hours for a full peak charge (from a complete dead to a full charge).
- Warning sound when battery charge is low.
- Economical child safe solution with no cords.
- 5 Year Motor Warranty

EZ Charge Version 2.0 (1.1Nm)

- Size Standards: [Pages 13-16](#) (window shades) or [page 24](#) (roman shades).
- Maximum Area of 64 sq ft. cannot be exceeded for any shade.
- Minimum width: 22"; Maximum width 96"
- Minimum height: 24"; Maximum height 120"
- Adjust speed: 40 RPM (30 RPM or 20 RPM)

EZ Charge X2 (Q-2Nm)

- Size Standards: [Pages 13-16](#) (window shades) or [page 24](#) (roman shades).
- Maximum Area of 80 sq ft. cannot be exceeded for any shade.
- Minimum width: 32"; Maximum width 120"
- Minimum height: 24"; Maximum height 120"
- Adjust speed: 28 RPM (24 RPM or 20 RPM)

EZ Charge X3 (Q-3Nm)

- Size Standards: [Pages 13-16](#) (window shades).
- Maximum Area of 144 sq ft. cannot be exceeded for any shade.
- Minimum width: 42"; Maximum width 144"
- Minimum height: 24"; Maximum height 120"
- Adjust speed: 28 RPM (24 RPM or 20 RPM)

Finished Dimensions

- Inside Mount (IS)
 - All systems: -1/8"
- Outside Mount (OS)
 - All systems: Ordered width
- Cloth Measure (CM):
 - SL Series Bracket: + 1 1/4"
 - R Series Bracket: + 1 1/4"
 - Small Cassette: + 1 3/16"
 - Large Cassette: + 1 3/16"

Ordering Notes

- Specify Inside or Outside Mount.
- Price as a standard shade, add the motor surcharge per shade.
- Add the Charger(s), Remote(s), and the Pulse Bridge.
- **Exclusions:** Season-Vue shades.



15 Channel Remote Control



Wall Switch



Charger with 12 foot cord



Pulse Bridge

Options - Version 2.0 and X2 Systems

- Surcharge
 - Board Mounted Shade with Fabric Wrapped Valance - Page 60
 - Cassette - Small or Large
 - Fascia - 3" Flat, 4" Flat, or 5" Flat
 - Mixed Metal Designer Accents on Cassette - [Page 61](#)
 - Pulse App Integration - Arc Wifi Bridge Kit - Sold separately
 - Surface Mount Wall Switch - Sold separately
 - Remote - 15 channel (White) - Sold separately
 - Accessories - Repeater, Solar Panel, Ext Cables-Sold separately

Options - X3 System

- Surcharge
 - Board Mounted Shade with Fabric Wrapped Valance - [Page 60](#)
 - Fascia - 4" or 5" Flat
 - Mixed Metal Designer Accents on [Fascia](#) - [Page 61](#)

Product Information

EZ Charge™ Lithium Rechargeable Series



EZ Charge Pulse Bridge

- Allows for app control over any of your EZ Charge Series motors.
- Set and manage up to 20 scenes.
- Set and manage up to 20 timers.
- Manage multiple hubs under multiple locations.
Easily switch between office and home.
Allows for up to 5 hubs under each location.
- Allows for third party serial integration.
- Amazon Alexa compatible.

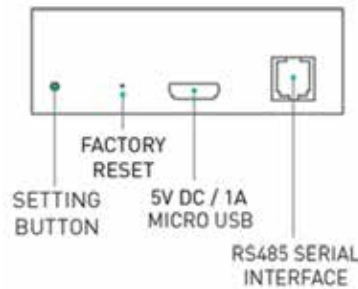

Features Summary:

- Controls up to 30 devices per hub
- Join multiple Pulse bridges together for multi-zone control
- Plug-and-play installation
- iOS & Android compatible
- Remote access

Technical Specifications

- Power input: 5VDC/1A
- Rated current: 500mA
- Rated power: <2.5W
- Standby power: <300mA
- WiFi Network: 802.11 b/g/n - 2.4 GHz
- Range Coverage: 30 m for device control
- Protection: IP20
- Antenna: Built-in
- 3.07 L x 3.07 W x .93 H

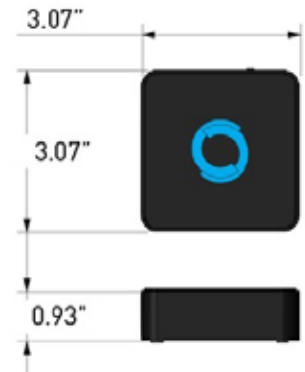
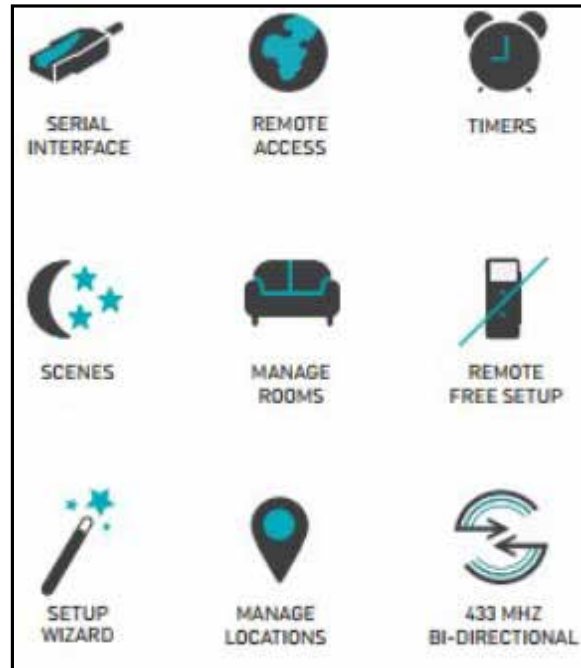

Motorization Services

- Customer Service Motorization Skill Set
- 800-342-5523
- motor@lafvb.com
- Technical Support by trained Customer Service Agents
- Assistance in the specification of motorization applications
- Liason between dealers/designers, electricians and home automation integrators.

EZ Charge Repeater

- Extends the RF range of operation up to 120 feet for ARC enabled products.
- Operates by plugging the USB power adapter into a power outlet and then plugging the USB Repeater into the USB power adapter.
- Press any button on the remote control and the blue light on the USB Repeater will flash three times. This means the USB Repeater is transmitting the signal.



Product Information

Q Motion Motorization



QMotion Battery Operated

Product Features

- **Extremely quiet operation**, industry leading innovation from QMotion.
- Completely free of cords and wires.
- Ability to move shades up and down manually with no remote.
Gently pull on the shade bottom to start shade moving.
- Convenience of moving the shade up or down, stopping at the top or bottom, four programmable intermediate stops or anywhere in between.
- Side gaps of 1/2" on each side are uniform.
- Concealed antenna.
- Most shades use standard alkaline D cell batteries, concealed in shade tube.
- Shades 15 1/2" to 22 1/2" use 3 AA batteries, concealed in shade tube.
- Easy battery replacement - change batteries without removing the shade.
- Battery life expectancy 2-5 years for D cell, 1-2 years with AA size batteries.
- Universal brackets can be used for IS mount, OS mount, ceiling mount, standard or reverse roll.

Size Standards

- Maximum sizes for shades using QMotion and QMotion Fascia are shown on [pages 17-20](#).
- Maximum height: 144"
- Minimum width: 15 1/2";
For widths 15 1/2" - 22", maximum length is 96".
- End caps extend 1/16" beyond the shade.
Lafayette does not take a deduction for the end caps.
- If window sizes vary within the same room then the tube sizes may vary. Contact the motorization queue with questions.

Ordering Notes

- Specify Inside or Outside Mount.
- Order Transmitter(s) or Wall Switch(s) as required.
- Check for other options required that are available.
- Motor left is standard roll; Motor right is reverse roll.
- Price as a standard shade, add the motor surcharge per shade and other surcharges (remote control, etc.).
- Shades are shipped in sleep mode; programming is done in the field.
- **Exclusions:** Season-View shades.
- Contact our motorization queue for any assistance or email motor@lafvb.com.

Mounting Requirements

• Inside Mount (IS) *

		Min Mtg Depth	Flush Mount
- Wall	2.6" Bracket	2 3/4"	3 1/2"
	3.3" Bracket	2 3/4"	3 3/4"
	2.6" Fascia	3 1/2"	3 3/8"
	3.3" Fascia	4 3/16"	4 1/16"
	4.3" Fascia	5 1/8"	5 1/4"

- Wall/Jamb	2.6" Bracket	1 1/2"	3 1/2"
	3.3" Bracket	1 1/2"	3 3/4"
	2.6" Fascia	1 3/4"	3 3/8"
	3.3" Fascia	1 1/2"	4 1/16"
	4.3" Fascia	2"	5 1/4"

- Ceiling/Jamb	2.6" Bracket	3"	3"
	3.3" Bracket	3 3/8"	3 3/8"
	2.6" Fascia	3 3/8"	3 3/8"
	3.3" Fascia	3 3/8"	3 3/8"
	4.3" Fascia	5 1/16"	5 1/4"

• Outside Mount (OS) - Minimum Flat Vertical Surface **

2.6" or 3.3" Bracket	3"
2.6" Fascia	3 1/8"
3.3" Fascia	4 3/16"
4.3" Fascia	5 1/8"

* Inside Mount dimensions include the recommended 1" clearance between the bracket and window.

** Outside Mount shades should be mounted 1/2" above window opening.

Finished Dimensions

- Inside Mount (IS): -1/8"
- Outside Mount (OS): Ordered width
- Cloth Measure (CM): + 1"

Product Information

Q Motion Motorization Options



Control Options

- **QDR Single Channel Remote**
 - 6 buttons to support Up/Down and preset positions 20%, 40%, 60%, 80%
 - Magnetic back for simple storing to wall plate.
 - Controls unlimited number of shades in a group.
 - Normal remote range is 30 feet.
- **QDR Multichannel Remote**
 - Up to 5 individual or group settings
 - All shades programmed to a multichannel remote are controlled together with an "All" button on same remote.
 - 6 buttons to support Up/Down and preset positions 20%, 40%, 60%, 80%
 - LED light feedback
 - Normal remote range is 30-50 feet.



Single Channel Remote



Multichannel Remote

Fascia and Valance Options

- **Fascia**
 - Available in three sizes - 2.6" Rollup, 3.3" Rollup or 4.3" Rollup
 - Fascia and snap on brackets with decorative end caps are available in four colors: Silver, White, Bronze and Black.
 - Light blocking woolpile on the top of fascia for better light control.
 - 2.6" Rollup Fascia is 3 1/2" high x 3 3/8" deep.
 - 3.3" Rollup Fascia is 4 3/16" high x 4 1/16" deep.
 - 4.3" Rollup Fascia is 5 1/4" high x 5 1/4" deep.
 - Note: QMotion Fascia is not available for a manual shade.



Qsync App

Other Accessories

- **Qrelay** - Extends range of all QMotion remotes 30 feet. Powered from a wall outlet or from a powered USB port.
- **Qsync Generation 3** - Control Qmotion shades via iPhone, iPad, iTouch. Android app control is also available. Communicates using Wi-Fi to router, router to Qsync, Qsync to shades approx. 30 feet.



Qrelay

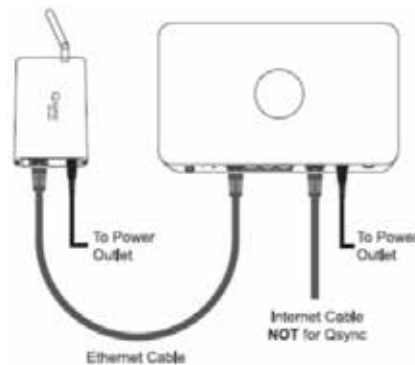

Qsync Diagram

Product Information

Window Shades with Sure-Lift Retractable Pull System

Version 2.0

Product Features

- Fits rectangular window openings.
- Includes frosted tassel.
- Cassette available in 5 colors: White, Vanilla, Bronze, Black, and Brushed Nickel. See [pages 82-84](#) for color coordination.
- Color-coordinated end cap, bottom rail and brackets.

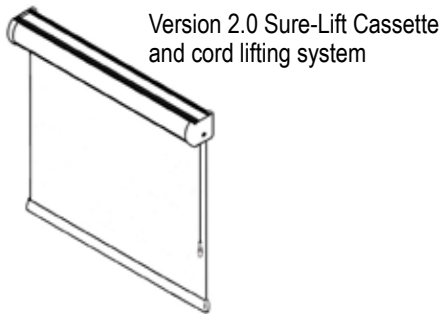

Mounting Requirements

- Inside Mount (IB)
 - Minimum Mounting Depth: 1 3/8"
 - Mounting Depth, Flush mount: 3 5/8"
- Outside Mount (OB)
 - Minimum Flat Vertical Surface: 1 3/8"

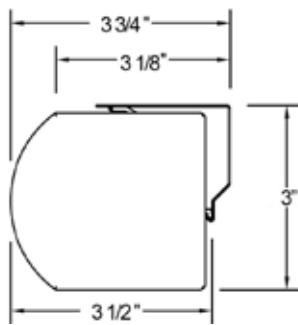

Finished Dimensions

- Inside Mount (IB)
 - Cassette: -1/8"
 - Shade Height: -1/8"
 - Fabric Width: -1 9/16"
- Outside Mount (OB)
 - Cassette: Ordered Width
 - Shade Height: Ordered Height
 - Fabric Width: -1 7/16"
- Light Gaps
 - Inside Mount (IB) - Includes 1/16" for IB
 - ♦ Control Side: - 3/4"
 - ♦ Non-Control Side: -1/2"
 - Outside Mount (OB)
 - ♦ Control Side: -11/16"
 - ♦ Non-Control Side: -7/16"

Size Standards

See Size Standards on [pages 5-8](#).

Standard Cord Drops

- Cord length is 2/3 of shade length.
- Cord length may be shortened at time of installation for improved child safety.

Hardware Included

- Installation Brackets

Options

- No Charge
 - Bottom Hem - Heat Sealed
 - Extension Brackets, Spacer Blocks
 - Hardware Color Substitution
- Surcharge
 - Bottom Hem - Decorative
 - Bottom Hem - Wood
 - Magnetic Hold Downs
 - Mixed Metal Designer Accents on Cassette - [Page 61](#)

Ordering Notes

- Only available with Sure-Lift cassette but will coordinate with Small Cassette in same room situations. (Sierra Tan not available)
- **Exclusions:** 2-on-1 headrail; Motorization; Fabric Tahiti.

Shade Operation

To lower the shade: Pull cord toward you, away from the shade with long, even strokes until the shade reaches the desired position. Allow cord to retract completely after each stroke.

To raise the shade: Pull the cord straight down using short, even strokes until the shade reaches the desired position. Allow the cord to retract completely after each stroke.

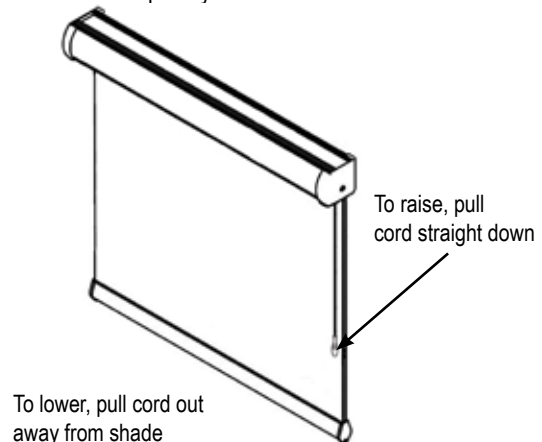

Product Information

Window Shades with EZ Pull

Product Features

- Fits rectangular window openings.
- Allows the shade to operate two different ways using a switch roller.
- Pulling on the bottom of the shade lowers the shade.
- Pulling on the back of the bead chain lowers the shade like a regular clutch system.
- Pulling on the front of the bead chain raises the shade
- White Raceway headrail with 1 1/2" aluminum tube.
- Fabric comes off the back of the roller.
- Wrapped metal hem bar.
- Color coordinated continuous bead chain loop, bottom rail, and end caps.



EZ Pull Inside Mount



EZ Pull Outside Mount

Mounting Requirements

• Inside Mount (IS) - Minimum Mounting Depth	
- EZ Pull	1 3/8"
- Large Cassette	1 1/4"
• Inside Mount (IS) - Mounting Depth - Flush Mount	
- EZ Pull	2 7/8"
- Large Cassette	4 7/16"
• Outside Mount (OS) - Minimum Flat Vertical Surface	
- EZ Pull	1"
- Large Cassette	1 3/8"

Finished Dimensions

- Inside Mount (IS)
 - EZ Pull: - 1/8"
 - EZ Pull with Large Cassette: - 1/8"
- Outside Mount (OS)
 - All systems: Ordered width
- Cloth Measure (CM)
 - EZ Pull: + 1"
 - Large Cassette: + 1 1/4"

Size Standards

See Size Standards on [pages 5-8](#).

Important Child Safety Note

In order to comply with the ANSI approved Standard For Safety of Window of Window Covering Products all supplied cord tension/locking devices or cord cleats must be properly installed.

Continuous Bead Chain Drops

Shade Length	Drop	Shade Length	Drop
Up to 22"	12"	54 1/16" - 66"	48"
22 1/16" - 27"	18"	66 1/16" - 78"	60"
27 1/16" - 39"	24"	78 1/16" - 90"	72"
39 1/16" - 42"	36"	90 1/16" - 102"	84"
42 1/16" - 54"	39"	Over 102"	96"

*Note: Custom lengths or lengths longer than 96" will have a connector. See [page 66](#).

Hardware Included

- Installation Brackets
- Cord Tension Lock

Options

- No Charge
 - Bead Chain Drop Substitution (table above)
 - Bottom Hem - Heat Sealed
 - P Clip Safety Tensioner
 - Reverse Roll - Max. height 96"
 - Sewn In Hem
- Surcharge
 - Bead Chain - Metal
 - Board Mounted Shade with Fabric Wrapped Valance - [Page 60](#)
 - Bottom Hem - Decorative
 - Cassette - Large
 - Magnetic Hold Downs
 - Mixed Metal Designer Accents on Cassette - [Page 61](#)

Ordering Notes

- Exclusions: Small Cassette; Motorization; Wood Bottom Hem; Decorative Pulls not available on wrapped metal hem.
- Fabric Exclusions: Shown on [pages 5-8](#).

Caution

- There is a VISIBLE light gap at the top on inside mount shades with an EZ Pull system, therefore the addition of a valance, cassette or cornice is STRONGLY advised.

Product Information

Window Shades with EZ Lift



Product Features

- Fits rectangular window openings.
- Speed reducer so shade will lift slowly.
- Shade can be stopped at any height.
- White Raceway headrail with 1 1/2" aluminum tube.
- Fabric comes off the back of the roller.
- Wrapped metal hem bar.
- Tension can be adjusted to increase or decrease speed
- Top limit can be set so hem bar height can be adjusted.
- No operating cords, superior child safe solution.



EZ Lift Inside Mount



EZ Lift Outside Mount

Mounting Requirements

• Inside Mount (IS) - Minimum Mounting Depth	
- EZ Lift:	2"
- Small Cassette	1 3/8"
- Large Cassette	1 1/4"
• Inside Mount (IS) - Mounting Depth - Flush Mount	
- EZ Lift	2 1/2"
- Small Cassette	3 5/8"
- Large Cassette	4 7/16"
• Outside Mount (OS) - Minimum Flat Vertical Surface	
- EZ Lift:	1"
- Small Cassette	1"
- Large Cassette	1 3/8"

Finished Dimensions

- Inside Mount (IS)
 - EZ Lift: -1/8"
 - EZ Lift with Small Cassette: - 1/8"
 - EZ Lift with Large Cassette: - 1/8"
- Outside Mount (OS): Ordered width
- Cloth Measure (CM)
 - EZ Lift: + 3/4"
 - Small Cassette: + 1 1/16"
 - Large Cassette: + 1 1/4"

Size Standards

See Size Standards on [pages 5-8](#).

For widths 18 1/2" to 26 1/2" shades are available up to 56" long.

For width 26 5/8" to 78" shades are available up to 84" long.

Important Child Safety Note

In order to comply with the ANSI approved Standard For Safety of Window of Window Covering Products all supplied cord tension/locking devices or cord cleats must be properly installed.

Hardware Included

- Installation Brackets

Options

- No Charge
 - Bottom Hem - Heat Sealed
 - Hold Down Brackets
 - Reverse Roll
 - Max. width 72"; Max. height 96"
- Surcharge
 - Board Mounted Shade with Fabric Wrapped Valance - [Page 60](#)
 - Bottom Hem - Decorative
 - Cassette - Large (Required after 72" height)
 - Cassette - Small
 - Magnetic Hold Downs
 - Mixed Metal Designer Accents on Cassette - [Page 61](#)
 - Valances & Cornices - [Pages 61-64](#)

Ordering Notes

- Uses White RaceWay Headrail up to 72" height; Large Cassette needed after 72" height.
- Exclusions: 2-on-1 Headrail; Motorization; Wood Bottom Hem; Decorative Pulls not available on wrapped metal hem.
- Fabric Exclusions: Shown on [pages 5-8](#).

Caution

- There is a VISIBLE light gap at the top on inside mount shades with an EZ Lift system, therefore the addition of a valance, cassette or cornice is STRONGLY advised.
- Outside mount reverse roll shades project out at least 1 1/2" from the wall causing a larger light gap. The shade fabric on reverse roll shades does not roll up as tightly as a regular roll shade. Avoid using stiff and heavy fabrics on reverse roll shades.

Product Information

Window Shades with Spring Roller

Product Features

- Fits rectangular window openings.
- Metal spring roller for smooth, reliable operation.
- Fabric comes off the back of the roller.
- Wrapped metal hem bar.



Size Standards

See Size Standards on [pages 9-12](#).

Hardware Included

- Installation Brackets

Options

- No Charge
 - Bottom Hem - Heat Sealed
 - Hold Down Brackets
 - Reverse Roll
 - Max. width 72"; Max. height 96"
 - Sewn In Hem
- Surcharge
 - Board Mounted Shade with Fabric Wrapped Valance - [Page 60](#)
 - Bottom Hem - Decorative
 - Magnetic Hold Downs
 - Sewn In Hem
 - Tube Size Upgrade
 - Valances & Cornices - [Pages 61-64](#)



Mounting Requirements

• Inside Mount (IS) - Minimum Mounting Depth		
- Ceiling	1" Tube	2"
	1 3/8" Tube	2 3/8"
	1 3/4" Tube	2 1/2"
- Wall	1" Tube	1 1/2"
	1 3/8" Tube	1 7/8"
	1 3/4" Tube	3/4"
- Flush	1" Tube	3"
	1 3/8" Tube	3 3/8"
	1 3/4" Tube	3 11/16"
• Outside Mount (OS) - Minimum Flat Vertical Surface		
	1" Tube	2 1/4"
	1 3/8" Tube	2 1/4"
	1 3/4" Tube	2 1/4"

Ordering Notes

- Exclusions: 2-on-1 Headrail; Wood Bottom Hem; Motorization, Decorative Pulls not available on wrapped metal hem.
- Fabric Exclusions: Shown on [pages 9-12](#).

Caution

- Outside mount reverse roll shades project out at least 1 1/2" from the wall causing a larger light gap. The shade fabric on reverse roll shades does not roll up as tightly as a regular roll shade. Avoid using stiff and heavy fabrics on reverse roll shades.

Finished Dimensions

- Inside Mount (IS): -1/8"
- Outside Mount (OS): Ordered width
- Cloth Measure (CM) for 1" or 1 3/8" tube: + 1 1/8"
- Cloth Measure (CM) for 1 3/4" tube: + 1 3/8"

Product Information

Window Shades - Top Down

Product Features

- Fits rectangular window openings.
- Shade lowers from the top to the bottom to allow light in the top portion of a window.
- R Series Clutch operating system at the top of the shade.
- Constant spring tension spring roller at bottom of the shade.
- Fabric comes off the back of the roller.
- Pulling on the clutch bead chain loop raises the shade.
- Wood slat moving rail with grommets guides the movement of the shade.
- Color coordinated continuous bead chain loop.

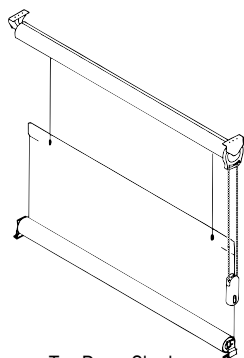

Top Down Shade with exposed roller

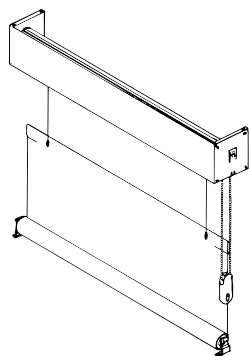

Top Down Shade with Recommended Optional Fascia

Mounting Requirements

• Inside Mount (IS) - Minimum Mounting Depth		
- R Series	1" Tube	1 3/4"
	2 1/2", 3 1/4" Tube	3 1/4"
	All other	2 3/4"
- 3", 4", 5" Fascia	All Tubes	7/8"
• Inside Mount (IS) - Mounting Depth - Flush Mount		
- R Series	1" Tube	2"
	2 1/2", 3 1/4" Tube	3 3/4"
	All other	2 3/4"
- 3" Fascia	All Tubes	3 1/8"
- 4" Fascia	All Tubes	4 1/8"
- 5" Fascia	All Tubes	5 1/8"
• Outside Mount (OS) - Minimum Flat Vertical Surface		
- R Series	1" tube	1 1/2"
- R Series	All other	2 1/2"
- 3" Fascia	All Tubes	1 7/8"
- 4" Fascia	All Tubes	3 7/8"
- 5" Fascia	All Tubes	4 7/8"

Finished Dimensions

- Inside Mount (IS): -3/16"
- Outside Mount (OS): Ordered width
- Cloth Measure (CM): +1"

Size Standards

See Size Standards on [pages 9-12](#).

Important Child Safety Note

In order to comply with the ANSI approved Standard For Safety of Window of Window Covering Products all supplied cord tension/locking devices or cord cleats must be properly installed.

Continuous Bead Chain Drops

Shade Length	Drop	Shade Length	Drop
Up to 22"	12"	54 1/16" - 66"	48"
22 1/16" - 27"	18"	66 1/16" - 78"	60"
27 1/16" - 39"	24"	78 1/16" - 90"	72"
39 1/16" - 42"	36"	90 1/16" - 102"	84"
42 1/16" - 54"	39"	Over 102"	96"

*Note: Custom lengths or lengths longer than 96" will have a connector. See [page 66](#).

Hardware Included

- Installation Brackets
- Cord Tension Lock

Options

- No Charge
 - Bead Chain Drop Substitution (table above)
 - Clutch Color Substitution (Black, Vanilla)
 - P Clip Safety Tensioner
- Surcharge
 - Bead Chain - Metal
 - Fascia - 3" Flat, 4" Flat
 - Mixed Metals Designer Accents on Fascia - [Page 61](#)
 - Tube Size Upgrade
 - Valances & Cornices - [Pages 61-64](#)

Ordering Notes

- Exclusions: 2-on-1 Headrail; 5" Contract Pocket; 5" Flat Fascia; Cassette; Decorative Hems; Decorative Pulls; Motorization; Reverse Roll.
- Fabric Exclusions: Shown on [pages 9-12](#).
- R Clutch brackets are specific to left or right side of shade.

Caution

- Thicker fabrics may require extension brackets to accommodate the fabric roll up.
- The roller tube at the top is exposed. Ordering a Fascia is HIGHLY RECOMMENDED.



Product Information

Window Shades with Light Blockout System

Product Features

- Fits rectangular window openings.
- Includes front fascia, side channels and bottom channel to eliminate light leakage. Customer selects fascia color.
- Select 3" flat fascia or 4" flat fascia in Brushed Nickel, Bronze, White or Vanilla.
- R Series Clutch roller system.
- Sewn in hem.
- Color coordinated continuous bead chain loop.
- 3" Fascia: Front Fascia is 3" high and 2 1/4" deep; Optional Top/Back Fascia is 3" high and 2 1/4" deep.
- 4" Fascia: Front Fascia is 4" high and 2 3/4" deep; Optional Top/Back Fascia is 4" high and 2 3/4" deep.
- Side Channels: Width of channel is 2 7/16".
- Bottom Channel: Height of channel is 2 7/16".

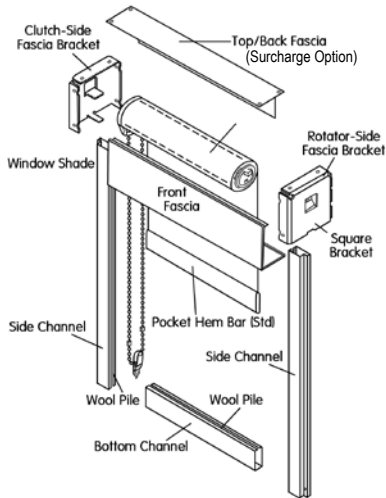

Mounting Requirements

• Inside Mount (IS) - Minimum Mounting Depth	
- 3" and 4" Fascia	7/8"
It is extremely important that the width given is an accurate measurement at the level where the fascia is to be installed. Squareness of the window is also critical for this installation.	
• Inside Mount (IS) - Mounting Depth - Flush Mount	
- 3" Fascia	3 1/8"
- 4" Fascia	4 1/8"
• Outside Mount (OS) - Minimum Flat Vertical Surface	
- 3" Fascia	1 7/8"
- 4" Fascia	3 7/8"

Finished Dimensions

- Inside Mount (IS)
 - 3" or 4" Fascia: -3/16"
- Outside Mount (OS): Ordered width
- Cloth Measure (CM): +1 3/16"

Size Standards

See Size Standards on [pages 5-8](#).

Important Child Safety Note

In order to comply with the ANSI approved Standard For Safety of Window of Window Covering Products all supplied cord tension/locking devices or cord cleats must be properly installed.

Continuous Bead Chain Drops

Shade Length	Drop	Shade Length	Drop
Up to 22"	12"	54 1/16" - 66"	48"
22 1/16" - 27"	18"	66 1/16" - 78"	60"
27 1/16" - 39"	24"	78 1/16" - 90"	72"
39 1/16" - 42"	36"	90 1/16" - 102"	84"
42 1/16" - 54"	39"	Over 102"	96"

*Note: Custom lengths or lengths longer than 96" will have a connector. See [page 66](#).

Hardware Included

- Installation Brackets
- Cord Tension Lock

Options

- No Charge
 - Bead Chain Drop Substitution (table above)
 - Clutch Color Substitution (Black, Vanilla)
 - P Clip Safety Tensioner
- Surcharge
 - Bead Chain - Metal
 - Fascia for Top/Back - 3" Flat or 4" Flat
 - Fascia - Fabric Wrapped
 - Tube Size Upgrade
 - Valances & Cornices - [Pages 61-64](#)

Ordering Notes

- Exclusions: 2-on-1 Headrail; Cassettes; 5" Flat Fascia; Mixed Metals Designer Accents; Motorization; Decorative Hems; Wood Bottom Hem; Decorative Pulls; Reverse Roll; Fabric Tahiti.
- To price, add the shade price to the Light Blockout Fascia surcharge.
- Control side cannot be changed once shade is made.
- There is a 1/8" gap between the side channel and the top fascia to allow for installation.

Caution

- For inside mounts, It is extremely important that the width given is an accurate measurement at the level where the fascia is to be installed. Squareness of the window is also critical for this installation.
- Inside Mounts are not recommended due to light leakage. If an Inside Mount is used then additional steps are necessary to minimize the light leakage. Options include caulking, filling or using a drapery panel on each side of the window.

Product Information

Season-Vue Window Shades



Product Features

- Fits rectangular window openings.
- Designed for use in enclosed patios, porches and lanais.
- Certain Genesis shade fabrics are available for use as a Season-Vue shade. See [pages 3-4](#) for availability.
- SL Exterior clutch shade with aluminum roller and stainless steel spring components in the clutch.
- Zinc-plated steel brackets with coating provide extra protection for screened-in applications.
- Wrapped metal hem bar adds weight and stability.
- Color coordinated continuous bead chain loop, bottom hem, and end caps.

Mounting Requirements

• Inside Mount (IS) - Minimum Mounting Depth		
- SL Series	1" Tube	2 5/16"
	2 1/2", 3 1/4" Tube	3"
	All other	2 7/16"
- 3", 4", 5" Fascia: 7/8"		
• Inside Mount (IS) - Mounting Depth - Flush Mount		
- SL Series	1" Tube	2 5/16"
	2 1/2", 3 1/4" Tube	3 11/16"
	All other	2 3/4"
- 3" Fascia	All Tubes	3 1/8"
- 4" Fascia	All Tubes	4 1/8"
- 5" Fascia	All Tubes	5 1/8"
• Inside Mount (IS) - Minimum Mounting Depth - Wall Mount		
- SL Series	All Tubes	3/4"
• Outside Mount (OS) - Minimum Flat Vertical Surface		
- SL Series	All tubes	2 1/4"
- 3" Fascia	All Tubes	1 7/8"
- 4" Fascia	All Tubes	3 7/8"
- 5" Fascia	All Tubes	4 7/8"

For R Series Mounting Requirements, see [page 67](#).

Finished Dimensions

- Inside Mount (IS):
 - Clutch - SL Series: -1/8"
 - Clutch - R Series: - 3/16"
 - Large Cassette: - 1/8"
- Outside Mount (OS): Ordered width
- Cloth Measure (CM)
 - Clutch - SL Series: + 1 1/8"
 - Clutch - R Series: + 1 3/16"
 - Large Cassette: + 1 1/4"

Size Standards

Season Vue shades with a clutch system can be made up to 144" wide based upon the fabric width and railroading availability.

See Size Standards on [pages 5-12](#) for Season-Vue shades made with a Large Cassette or Fascia system.

Important Child Safety Note

In order to comply with the ANSI approved Standard For Safety of Window of Window Covering Products all supplied cord tension/locking devices or cord cleats must be properly installed.

Continuous Bead Chain Drops

Shade Length	Drop	Shade Length	Drop
Up to 22"	12"	54 1/16" - 66"	48"
22 1/16" - 27"	18"	66 1/16" - 78"	60"
27 1/16" - 39"	24"	78 1/16" - 90"	72"
39 1/16" - 42"	36"	90 1/16" - 102"	84"
42 1/16" - 54"	39"	Over 102"	96"

*Note: Custom lengths or lengths longer than 96" will have a connector. See [page 66](#).

Hardware Included

- Installation Brackets
- Cord Tension Lock

Options

- No Charge
 - Bead Chain Drop Substitution (table above)
 - Heat sealed bottom hem with a white metal bar inserted (N/A on certain fabrics - [Pages 62-63](#))
 - P Clip Safety Tensioner
 - R Series Season-Vue Clutch Substitution (Black, Vanilla)
 - Reverse Roll
 - SL Clutch Color Substitution (Black, White)
- Surcharge
 - 2-on-1 Headrail
 - Bead Chain - Stainless Steel
 - Cassette - Large - Maximum width 120"
 - Exterior Cable Guide System (OS Mount only / SL Clutch only) (96" x 96" maximum shade size) See [page 57](#) for full description.
 - Fascia - 3" Flat, 4" Flat, and 5" Flat
 - Magnetic Hold Downs
 - Tube Size Upgrade

Ordering Notes

- Exclusions: Decorative Hems; Wood Bottom Hem; Small Cassette; Motorization.
- **Dealer must specify Season-Vue shade at the beginning of the shade order.**
- To price, add the shade price to the Season-Vue surcharge.
- SL Clutch brackets are universal for inside mount, outside mount, ceiling mount, standard or reverse roll shades.
- Fascia brackets utilize an end plate.

Caution

- Wind Advisory: Because these shades are exposed to some environmental elements, such as wind, it is advisable to roll up the shades BEFORE there are windy conditions.

Product Information

Season-Vue with Exterior Cable Guide System



Product Features

- Available as an option, a cable guide system designed for Genesis Season-Vue shades.
- Designed for use in enclosed patios, porches and lanais.
- Outside Mount only.
- SL Exterior clutch shade with aluminum roller and stainless steel spring components in the clutch.
- SL Clutch, if fascia option is not ordered.
- Certain Genesis shade fabrics are available for use as a Season-Vue shade. See [pages 3-4](#) for availability.
- Maximum size: 96" wide x 96" height
- Zinc-plated steel brackets with coating provide extra protection for screened-in applications.
- Bottom Bar allows steel cable to move shade vertically with minimal swaying.
- Tie down anchor for the cable guide is white.



Mounting Requirements

• Outside Mount (OS) - Minimum Flat Vertical Surface		
- SL Series	All tubes	2 1/4"
- 3" Fascia	All Tubes	1 7/8"
- 4" Fascia	All Tubes	3 7/8"

Finished Dimensions

- Outside Mount (OS): Ordered width
- Cloth Measure (CM)
 - Clutch - SL Series: + 1 1/8"
 - Clutch - R Series: + 1 3/16"

Size Standards

Maximum Shade Size: 96" wide (or fabric width) x 96" length.

Continuous Bead Chain Drops

Shade Length	Drop	Shade Length	Drop
Up to 22"	12"	54 1/16" - 66"	48"
22 1/16" - 27"	18"	66 1/16" - 78"	60"
27 1/16" - 39"	24"	78 1/16" - 90"	72"
39 1/16" - 42"	36"	90 1/16" - 102"	84"
42 1/16" - 54"	39"	Over 102"	96"

*Note: Custom lengths or lengths longer than 96" will have a connector. See [page 66](#).

Important Child Safety Note

In order to comply with the ANSI approved Standard For Safety of Window of Window Covering Products all supplied cord tension/locking devices or cord cleats must be properly installed.

Hardware Included

- Installation Brackets
- Tie Down Anchors (White)

Options

- No Charge
 - SL Clutch Color Substitution (Black, White)
- Surcharge
 - Bead Chain - Stainless Steel
 - Exterior Cable Guide System (required)
 - Fascia - 3" Flat, 4" Flat (using R Series brackets)
 - Mixed Metals Designer Accents - [Page 61](#)
 - Tube Size Upgrade

Ordering Notes

- Exclusions: Cassettes; 5" Fascia; Decorative Hems; Wood Bottom Hem; Decorative Pulls with a wrapped metal hem bar; Motorization
- Dealer must specify Season-Vue shade at the beginning of the shade order.
- To price, add the shade price to the Season-Vue surcharge and then add the Exterior Cable Guide surcharge.
- Fascia brackets utilize an end plate.

Caution

- Wind Advisory: Because these shades are exposed to some environmental elements, such as wind, it is advisable to roll up the shades BEFORE there are windy conditions.

Design Options

Window Shades - Cassette Systems

Small Cassette Systems

- Fits rectangular window openings.
- R Series Clutch
- See Size Standards on [pages 5-8](#).
- Available in Brushed Nickel, White, Vanilla, Sierra Tan, Bronze and Black. See [pages 82-84](#) for color coordination chart.
- Fabric inserted into front of cassette.
- The wrapped metal hem prevents the shade material from rolling completely into the cassette.

Options

- No Charge
 - Cassette Color Substitution
 - Cassette with no fabric insert
- Surcharge
 - 2-on-1 Headrail - Maximum width 156"
 - Mixed Metals Designer Accents (no wrap on end caps)
 - Motorization

Ordering Notes

- Exclusions: Reverse Roll Shades; Fabric Tahiti.
- To price, add shade price and cassette surcharge.

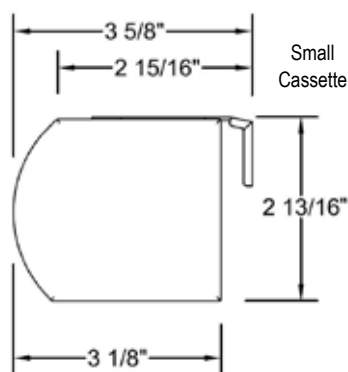

Large Cassette System

- Fits rectangular window openings.
- SL Series Clutch
- See Size Standards on [pages 5-8](#).
- Available in Brushed Nickel, White, Vanilla, Sierra Tan, Bronze and Black. See [pages 82-84](#) for color coordination chart.
- Fabric inserted into front of cassette.
- The wrapped metal hem prevents the shade material from rolling completely into the cassette.

Options

- No Charge
 - Cassette Color Substitution
 - Cassette with no fabric insert
- Surcharge
 - 2-on-1 Headrail - Maximum width 156"
 - Mixed Metals Designer Accents (no wrap on end caps)
 - Motorization

Ordering Notes

- Exclusions: Reverse Roll Shades; Fabric Tahiti.
- To price, add shade price and cassette surcharge.

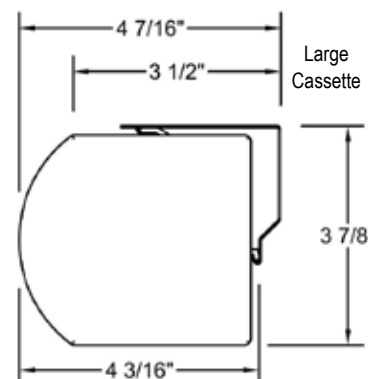

Mounting Requirements

- Inside Mount (IB)
 - Minimum Mounting Depth
 - ♦ Small Cassette: 1 3/8"
 - ♦ Large Cassette: 1 1/4"
 - Mounting Depth, flush mount
 - ♦ Small Cassette: 3 5/8"
 - ♦ Large Cassette: 4 7/16"
- Outside Mount (OS) - Min Mounting Height:
 - ♦ Small Cassette: 1 7/8"
 - ♦ Large Cassette: 2"

Finished Dimensions

- Inside Mount (IB)
 - Cassette: -1/8"
 - Shade Height: -1/8"
 - Fabric Width: -1 1/4"
- Outside Mount (OB)
 - Cassette: Ordered Width
 - Shade Height: Ordered Height
 - Fabric Width: -1 1/8"
- Light Gap information given below based on lift system.

	Inside Mount Light Gaps	
	Control Side	Non Control Side
R Series Clutch**	- 3/4"	- 7/16"
SL Series Clutch***	- 3/4"	- 7/16"
EZ Pull ***	- 15/16"	- 7/16"
EZ Lift	- 5/8"	- 1/4"
Auto-Wand	- 13/16"	- 1/2"
System II	- 13/16"	- 1/2"
Sonesse 30 WF	- 11/16"	- 1/2"
EZ Charge (All)	- 13/16"	- 1/2"

**Small Cassette Only

*** Large Cassette Only

	Finished Dimensions	Outside Mount Light Gaps	
	Cloth Measure *	Control Side	Non Control Side
R Series Clutch**	+ 1 1/16"	- 11/16"	- 3/8"
SL Series Clutch***	+ 1 1/4"	- 11/16"	- 9/16"
EZ Pull***	+ 1 1/8"	- 3/4"	- 3/8"
EZ Lift	+ 3/4"	- 9/16"	- 3/16"
Auto-Wand	+ 1 3/16"	- 3/4"	- 7/16"
System II	+ 1 3/16"	- 3/4"	- 7/16"
Sonesse 30 WF	+ 1 1/16"	- 5/8"	- 7/16"
EZ Charge (All)	+ 1 3/16"	- 3/4"	- 7/16"

* Overall shade width when ordered

**Small Cassette Only

*** Large Cassette Only

Design Options

Window Shades - Fascia and Pocket Systems

3" and 4" Fascia

- Fits rectangular window openings.
- R Series Clutch
- See Size Standards on [pages 9-12](#).
- Available in Brushed Nickel, White, Vanilla, Bronze and Black.
Specify Front OR Front and Back Fascia.
- Bracket covers are standard for OS mounts.
- 3" Flat Front Fascia: Fascia is 3" high; Bottom Edge is 2 1/4" deep
- 4" Flat Front Fascia: Fascia is 4" high; Bottom Edge is 2 3/4" deep

Options

- Surcharge
 - Brackets - Adjustable - 3" and 4" Fascia only
 - Fascia - Back
 - Fascia - Fabric Wrapped - [Pages 62-63](#) for fabric availability
 - Mixed Metals Designer Accents - [Page 61](#)
 - Motorization

Ordering Notes

- Exclusions: Spring Roller; Reverse Roll Shades; Fabrics Tahiti and Light-Vue.
- To price, add shade price and fascia surcharge.
- Caution: The hem bar will NOT roll up in the Fascia.
- Bracket covers add 1/4" to overall width.
- For inside mounts, it is extremely important that the width given is an accurate measurement at the level where the fascia is to be installed.

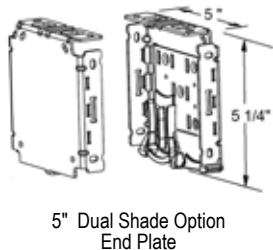

5" Flat Fascia

- Fits rectangular window openings.
- SL Series Clutch
- See Size Standards on [pages 9-12](#).
- Available in Brushed Nickel, White and Bronze.
- Bracket covers are standard for OS mounts.
- Can be used as a Dual Shade Option - an endplate in the 5" Fascia bracket will hold two shades with controls on the same side and appear as one unit.
- Minimal fascia light gap across the header since the top of the fascia is even with the top of the brackets. Uses chain diverters and guides to eliminate notching of the fascia.
- For inside mounts, it is extremely important that the width given is an accurate measurement at the level where the fascia is to be installed.
- Fascia is 5 3/16" high, 3 13/16" deep.

Options

- Surcharge
 - Fascia - Back
 - Fascia - Fabric Wrapped - [Pages 62-63](#) for fabric availability
 - Mixed Metals Designer Accents - [Page 61](#)
 - Motorization

5" Contract Pocket

- Installs in recessed pocket ceiling openings.
- SL Series Clutch
- See Size Standards on [pages 9-12](#).
- Available in Anodized and White.
- Can be used as a Dual Shade Option
- Pocket Fascia is 5 5/16" high, 5 5/8" deep.
- Bottom Gravity Lip is 2 5/8" wide allowing 2" opening for shade. The gravity lip is used on single shade applications only.
- Installation brackets are not provided since installation is job site dependent.

Options

- No Charge
 - Reverse Roll
- Surcharge
 - Gravity Lip (Single shade application only)
 - Motorization

Ordering Notes for 5" Flat Fascia and 5" Pocket

- Exclusions: Spring Roller; Reverse Roll Shade for 5" Flat Fascia; Top Down Shade; Light Blockout System; Fabric Tahiti.
- To price, add fascia or pocket surcharge to the shade price.
- Caution: The bottom rail will NOT roll up in the Fascia.
- Bracket covers add 1/4" to overall width.

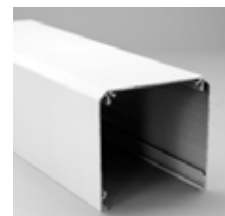
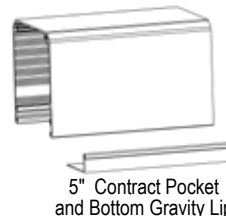

Design Options

Window Shades - Board Mounted Shade

Product Features

- Fits rectangular window openings.
- Board mounted shade with Fabric Wrapped Valance.
- Valance is wrapped in shade material.
- 4 5/8" high valance, fabric has velcro attachment to the board.



Fabric Wrapped Valance

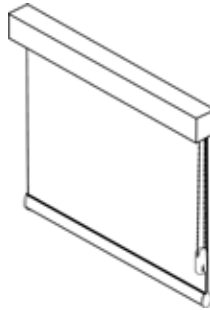

Mounting Requirements

- Inside Mount (IB)
 - Minimum Mounting Depth: 1"
 - Minimum Mounting Depth, Flush mount: 3 1/2"
- Outside Mount (OS) - Flat Vertical Surface: 2"

Finished Dimensions

- Inside Mount (IS): - 1/8"
- Outside Mount (OS): Ordered Width
- Light Gap information given below based on lift system.

	Inside Mount Light Gaps	
	Control Side	Non Control Side
R Series Clutch	+ 11/16"	+ 11/16"
SL Series Clutch	+ 11/16"	+ 7/16"
EZ Pull	+ 13/16"	+ 5/16"
EZ Lift	+ 1/4"	+ 3/16"
Auto-Wand	+ 3/4"	+ 3/4"
System II	+ 3/4"	+ 3/4"
Sonessa 30 WF	+ 9/16"	+ 3/4"
EZ Charge (All)	+ 3/4"	+ 3/4"
QMotion	+ 9/16"	+ 1/2"

	Finished Dimensions Cloth Measure *	Outside Mount Light Gaps	
		Control Side	Non Control Side
R Series Clutch	+ 1 1/8"	- 5/8"	- 5/8"
SL Series Clutch	+ 1"	- 5/8"	- 3/8"
EZ Pull	+ 1"	- 3/4"	- 1/4"
EZ Lift	+ 5/16"	- 3/16"	- 1/8"
Auto-Wand	+ 1 3/8"	- 11/16"	- 11/16"
System II	+ 1 3/8"	- 11/16"	- 11/16"
Sonessa 30 WF	+ 1 1/16"	- 1/2"	- 11/16"
EZ Charge (All)	+ 1 3/8"	- 11/16"	- 11/16"
QMotion	+ 15/16"	- 1/2"	- 7/16"

* Overall shade width when ordered

Size Standards

See Size Standards on [pages 5-8](#).

Hardware Included

- Installation Brackets
- Cord Tension Lock

Options

- No Charge
 - Majesty Wood Valance or Noble 4 5/8" Valance in place of Fabric Wrapped Valance
- Surcharge
 - 2-on-1 Headrail (Maximum width 95")
 - 7" Fabric Wrapped Valance

Fabric Wrapped Valance Returns

- For inside mounts, no returns will be sent unless specified (see undersize return).
- **Standard Return** - The standard return is 3 1/4" (measured from the back of valance) with a 3" mounting board.

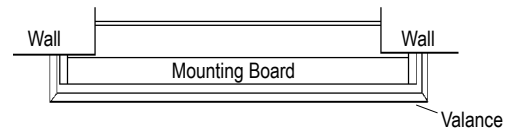

- **Upsize Return** - required for an outside mount on trim or when using extension brackets. The size you specify is equal to the depth of the trim (wall to the high point of the trim) or the depth of the extension brackets. We will add that measure to the standard return.

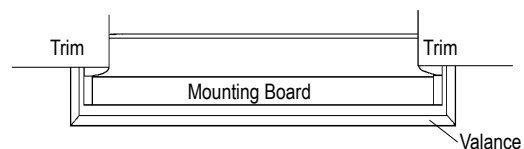

- **Undersize Return** - required for an inside mount protruding into the room. The size you specify is equal to the recessed mounting depth.



- **Exact Size Return** - The size you specify is equal to the measurement from the back of the return to the back of the valance face (inside miter).

Ordering Notes

- Exclusions: Sure-Lift.
- See [pages 62-63](#) for fabrics not available with a Fabric Wrapped Valance. For those fabrics a Majesty Wood Valance or 4 5/8" Noble Wood Valance can be substituted for no additional charge.

Design Options

Window Shades - Wood Valances & Metal Accents

Majesty, Noble or Camelot Wood Valance

- Valances are available in 14 colors: Accessible Beige, Buckeye, Cottage Pine, Ebony Wash, Gardenia, Harmony, Java Roast, Mahogany, Moonshine, Natural, Navajo White, Revere Pewter, Snow White, Thunder. Sample chips are available using MySwatch.
- Standard return is 4 1/2" from back of valance to wall.
- If wood valance width is over 96" the valance will be spliced.
- L Bracket with panhead nut & bolt is used for attachment through the top of the dust cover.

Ordering Notes

- Caution: Recommended for Window Shades only. A Camelot, Majesty, or Noble 4 5/8" Wood Valance installed over a roman shade will NOT fully cover shade hardware and cords.

Majesty Valance
4 1/2" height
5/8" thick

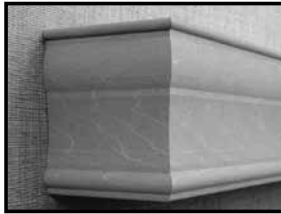

Noble Valance
4 5/8" height
1/2" thick



Camelot Valance
3 1/2" height
1/2" thick

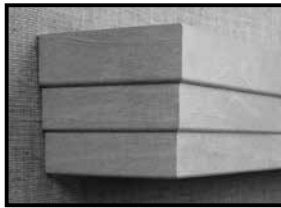

Mixed Metal Designer Accents

The face of the cassette, fascia or Sure-Lift cassette can be covered with one of the six Designer Accent materials. The bottom rail is not wrapped with the accent fabric.

- Available for Small and Large Cassette, Sure-Lift, Fascias.
- Maximum width 120".
- For 2-on-1 Headrail use overall width to price.
- Hardware is color-coordinated to Genesis material unless specified.
- Colors available: Brushed Sterling, Brushed Titanium, Brushed Graphite, Bronze Shimmer, Radiant Cashmere, and Bronze Pearl.



Design Options

Window Shades - Fabric Valances and Hemlines

Fabric Name	Fabric Width	Fabric Wrapped Valance	Fabric Wrapped Fascia	Shade Valance	4" or 7" Cornice	Channel Panel Valance	Decorative Hem	Heat Sealed Bottom Hem	Wood Bottom Hem
Adele	110"	✓	✓	✓	✓	✓	✓	⊘	✓
Aedan	79"	✓	✓	✓	✓	✓	✓	⊘	✓
Beatty	72"	✓	✓	✓	✓	✓	✓	⊘	✓
Berber Slub	72"	✓	✓	✓	✓	✓	⊘	⊘	✓
Boho	94"	⊘	✓	✓	✓	✓	✓	⊘	✓
Boucle	72"	✓	✓	✓	✓	✓	✓	✓	✓
Brit	98"	✓	✓	✓	✓	✓	⊘	⊘	✓
Cabos	108"	⊘	✓	✓	✓	✓	⊘	⊘	✓
Cayman	110"	✓	✓	✓	✓	✓	✓	⊘	✓
Charmed	110"	✓	✓	✓	✓	✓	⊘	⊘	✓
Dakota	90"	✓	✓	✓	✓	✓	✓	⊘	✓
Dallas	72"	✓	✓	✓	✓	✓	✓	⊘	✓
Deco Screen	98"	✓	✓	✓	✓	✓	⊘	⊘	✓
Dimensions 3% / 5%	120"	✓	✓	✓	✓	✓	⊘	✓	✓
Duo Vue	98"	✓	✓	✓	✓	✓	⊘	⊘	✓
E Screen 3% / 5%	122"	✓	✓	✓	✓	✓	⊘	⊘	✓
E Screen KOOLBLACK 5%	122"	✓	✓	✓	✓	✓	⊘	⊘	✓
Economy Screen	118"	⊘	⊘	⊘	⊘	⊘	⊘	⊘	✓
Fedora	72"	✓	✓	✓	✓	✓	✓	⊘	✓
Fiber-Lucent	72"	✓	✓	✓	✓	✓	✓	✓	Y
Flutter	96"	✓	✓	✓	✓	✓	⊘	⊘	Y
Garbo	110"	✓	✓	✓	✓	✓	⊘	⊘	Y
Grasscloth	72"	✓	✓	✓	✓	✓	✓	⊘	✓
Harper	115"	✓	✓	✓	✓	✓	✓	⊘	✓
Highland	118"	✓	✓	✓	✓	✓	✓	⊘	✓
Hombre	72"	✓	✓	✓	✓	✓	✓	⊘	✓
Homespun	79"	✓	✓	✓	✓	✓	✓	⊘	✓
Jackson	72"	✓	✓	✓	✓	✓	✓	⊘	✓
Katrina	98"	✓	✓	✓	✓	✓	✓	⊘	✓
Keilani	108"	✓	✓	✓	✓	✓	⊘	⊘	Y
Kendo	94"	✓	✓	✓	✓	✓	⊘	⊘	Y
Lexie	110"	✓	✓	✓	✓	✓	✓	⊘	✓
Light-View	72"	⊘	⊘	⊘	⊘	⊘	⊘	⊘	⊘
Lindley	72"	✓	✓	✓	✓	✓	✓	⊘	✓
Linen	78"	✓	✓	✓	✓	✓	✓	⊘	✓
Lizzy	86"	✓	✓	✓	✓	✓	✓	⊘	✓
Long Bay	110"	✓	✓	✓	✓	✓	✓	⊘	✓
Long Bay Blackout	106"	✓	✓	✓	✓	✓	✓	⊘	✓
Loretta	72"	✓	✓	✓	✓	✓	✓	⊘	✓
Lucinda	72"	✓	✓	✓	✓	✓	✓	⊘	✓
Luminescence	94"	✓	✓	✓	✓	✓	⊘	⊘	⊘
Lux Screen	98"	✓	✓	✓	✓	✓	✓	⊘	✓
Moire	72"	✓	✓	✓	✓	✓	✓	✓	✓
Mystic	108"	✓	✓	✓	✓	✓	⊘	⊘	✓
Mystic Eclipse	110"	✓	✓	✓	✓	✓	✓	⊘	✓
Net 3000	118"	✓	✓	✓	✓	✓	⊘	⊘	✓
No-Lite Fiberglass Duplex	72"	✓	✓	✓	✓	✓	✓	✓	✓
No-Lite Fiberglass Solids	72"	✓	✓	✓	✓	✓	✓	✓	✓
Nordicscrn Plus BW 3%/5%	118"	✓	✓	✓	✓	✓	⊘	✓	✓
Nordicscrn Plus Twill 1%/3%	118"	✓	✓	✓	✓	✓	⊘	✓	✓
Opulence	118"	✓	✓	✓	✓	✓	⊘	⊘	✓
Origami	108"	⊘	✓	✓	✓	✓	⊘	⊘	✓
Pacifica	110"	✓	✓	✓	✓	✓	✓	⊘	✓

Notes: Magnetic hold downs cannot be used with a heat sealed bottom hem.

Design Options

Window Shades - Fabric Valances and Hemlines

Fabric Name	Fabric Width	Fabric Wrapped Valance	Fabric Wrapped Fascia	Shade Valance	4" or 7" Cornice	Channel Panel Valance	Decorative Hem	Heat Sealed Bottom Hem	Wood Bottom Hem
Palm Beach	118"	✓	✓	✓	✓	✓	✓	⊗	✓
Pearlescent	78"	✓	✓	✓	✓	✓	✓	⊗	✓
Persia	110"	✓	✓	✓	✓	✓	✓	⊗	✓
Petticoat	110"	⊗	⊗	✓	✓	✓	⊗	⊗	✓
Princeton	78"	✓	✓	✓	✓	✓	✓	⊗	✓
Reserved	94"	✓	✓	✓	✓	✓	⊗	⊗	✓
Rocky Mountain	70"	✓	✓	✓	✓	✓	✓	⊗	✓
Rollie	79"	✓	✓	✓	✓	✓	✓	⊗	✓
S Screen Elements	122"	✓	✓	✓	✓	✓	⊗	⊗	✓
S Screen Origins	122"	✓	✓	✓	✓	✓	⊗	⊗	✓
Safari	72"	✓	✓	✓	✓	✓	⊗	⊗	✓
Scala Blackout	110"	✓	✓	✓	✓	✓	⊗	⊗	✓
Seclusion	120"	✓	✓	✓	✓	✓	✓	✓	✓
Sedona	110"	✓	✓	✓	✓	✓	✓	⊗	✓
Serene	98"	✓	✓	✓	✓	✓	✓	⊗	✓
Seto 5000	110"	✓	✓	✓	✓	✓	✓	⊗	✓
Seto 6000	110"	✓	✓	✓	✓	✓	✓	⊗	✓
Shantung	79"	✓	✓	✓	✓	✓	✓	⊗	✓
SheerWeave 1000	96"	⊗	⊗	⊗	⊗	⊗	⊗	⊗	✓
SheerWeave 2000	126"	✓	✓	✓	✓	✓	⊗	✓	✓
SheerWeave 2390	126"	✓	✓	✓	✓	✓	⊗	✓	✓
Sheerweave 2410	126"	✓	✓	✓	✓	✓	⊗	✓	✓
SheerWeave 2500	126"	✓	✓	✓	✓	✓	⊗	✓	✓
SheerWeave 3000	96"	✓	✓	✓	✓	✓	⊗	⊗	✓
SheerWeave 4100	98"	✓	✓	✓	✓	✓	⊗	✓	✓
SheerWeave 4400	126"	✓	✓	✓	✓	✓	⊗	✓	✓
SheerWeave 5000	98"	✓	✓	✓	✓	✓	⊗	✓	✓
SheerWeave 7000	118"	✓	✓	✓	✓	✓	✓	⊗	✓
SheerWeave 7400	118"	✓	✓	✓	✓	✓	✓	⊗	✓
SheerWeave 7450	118"	✓	✓	✓	✓	✓	✓	✓	✓
Sheerweave Inf 2 3% / 5%	98"	⊗	⊗	✓	✓	✓	⊗	⊗	✓
Sheerweave Perf 2390	96"	⊗	⊗	✓	✓	✓	⊗	⊗	✓
Sheerweave Perf 2410	96"	⊗	⊗	✓	✓	✓	⊗	⊗	✓
Solar Screen 3000 1% / 3%	118"	✓	✓	✓	✓	✓	⊗	✓	✓
Spector	84"	✓	✓	✓	✓	✓	✓	⊗	✓
Spiral	102"	✓	✓	✓	✓	✓	✓	⊗	✓
Strata	81"	✓	✓	✓	✓	✓	✓	⊗	✓
Strie	72"	✓	✓	✓	✓	✓	✓	⊗	✓
Superwide	106"	✓	✓	✓	✓	✓	✓	⊗	✓
Tahiti	70"	⊗	✓	✓	✓	✓	⊗	⊗	✓
Triad	118"	✓	✓	✓	✓	✓	⊗	⊗	✓
T-Screen Koolblack 3% / 5%	122"	✓	✓	✓	✓	✓	⊗	⊗	✓
Tussah	110"	✓	✓	✓	✓	✓	✓	⊗	✓
Valencia	94"	✓	✓	✓	✓	✓	✓	⊗	✓
Viking (TFR)	72"	✓	✓	✓	✓	✓	✓	⊗	✓
Vision	118"	✓	✓	✓	✓	✓	⊗	✓	✓
Vista Screen	98"	✓	✓	✓	✓	✓	⊗	⊗	✓
Vizela	94"	✓	✓	✓	✓	✓	✓	⊗	✓
Wave	72"	✓	✓	✓	✓	✓	✓	⊗	✓
Weave	72"	✓	✓	✓	✓	✓	⊗	⊗	✓
Willow	72"	✓	✓	✓	✓	✓	✓	⊗	✓
Yellowstone	72"	✓	✓	✓	✓	✓	✓	⊗	✓
Zootime	86"	✓	✓	✓	✓	✓	✓	⊗	✓

Notes: Magnetic hold downs cannot be used with a heat sealed bottom hem.

Design Options

Window Shades - Fabric Valances and Cornice

Stand Alone Fabric Wrapped Valance

- 4 1/2" or 7" high valance is fabric covered and is attached to the board with velcro.
- Available with 3 1/4" returns (3" board) and 5 1/4" returns (5" board).
- See Return Measurement for Fabric Wrapped Valances on [page 60](#).
- Maximum width of valance is 95".
- See [pages 62-63](#) for fabric availability.



Shade Valance

- Shade valance has a 1 1/2" rod pocket on top and bottom for additional stability; Oval curtain rods with 3 1/2" returns are **included** in the price.
- The shade valance measures 7" from the top of the rod pocket to the bottom of bottom rod pocket.
- Valance is available with no returns for inside mounts; specify at time of order.
- Valance pricing is for a plain hem.
- Maximum valance width is 98" or the shade fabric width, whichever is less.
- When the valance width including returns exceeds the maximum fabric width, the material will be railroaded for fabrication (when acceptable); **otherwise, the material will have to be seamed!**
- See [pages 62-63](#) for fabric availability.



Shade Valance
7" height

Shade Cornice

- A skeleton wood frame provides stability to the sides of the cornice and a tailored look to the cornice.
- The shade cornice measures 4" or 7" from the top of the board to the bottom of the cornice.
- Standard projection is 3 1/2"; Projection of 5 1/2" can be specified at no additional charge. Other projections can be requested for a surcharge.
- Cornice pricing shown is for a plain hem. For a Decorative Hem (applique only, not scallops) add the Decorative Hem surcharge.
- Cornice is shipped assembled.
- The cornice board is painted or stained to coordinate with the fabric.
- When the cornice width including returns exceeds the maximum fabric width, the material will be railroaded for fabrication (when acceptable); **otherwise, the material will have to be seamed!**
- See [pages 62-63](#) for fabric availability.

Ordering Notes

- Caution: A 4" Cornice installed over a shade may not fully cover shade hardware and cords.

Cornice
4" height



Cornice
7" height



Channel Panel Valance

- The Genesis shade material is inserted into the channel panel.
- Maximum width is 84".
- L Bracket with panhead nut and bolt is used for attachment through the top of the valance.
- The tailored square corner provides a clean look over the window shade. Rounded corners are not available.
- Caution: A Channel Panel Valance installed over a shade may not fully cover shade hardware and cords.
- See [pages 62-63](#) for fabric availability.



Channel Panel Valance
3 1/2" height

Design Options

Window Shades - Hemlines

Decorative Hems

- Refer to [pages 3-4](#) to determine if a fabric is available with a Decorative Hem.
- Select Decorative Hem Style from pictures shown here or in the Genesis Sample Book.
- Pricing for the decorative hem is based upon hem type selected. See [page 30](#) for Hemline Surcharges.
- The center point for each scallop style will be consistent for each order. **If you desire scallop placement exactly as pictured, you must request such placement at the time of the order.**
- If more than one row of trim is specified, there is an allowance of 1" between rows. Gimp surcharge is a per row surcharge.
- Gimp colors can vary from the sample to the finished product.
- Simple scallop styles are recommended for narrow shades.
- Exclusion: All screen materials - see [pages 3-4](#).

Gimp Color Selection

- Gimp is available in the following colors:
- | | | | | |
|--------|--------|-------|-------|-----------|
| Baltic | Brandy | Camel | Ivory | Sandstone |
| Black | Brown | Gold | Moss | White |



4" Contrasting Fabric Pocket 275
Also available in 1 1/2" Pocket 270



Royal 210
Approx repeat 7 1/4"



6" Contrasting Fabric with Gimp 285
Also available with 3" Contrasting Fabric 280

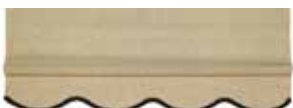

Tempo 203
Approx repeat 9 1/8"



Brenda 213
Approx repeat 7 1/2"

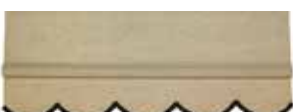

Wave 206
Approx repeat 7 1/4"

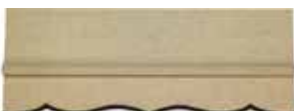

Diane 222
Approx repeat 9 1/2"

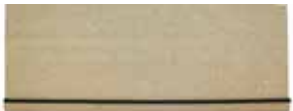

Winchester 112
Trim is on stitch line

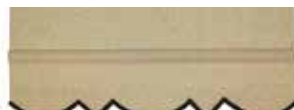

Harlequin 215
Approx repeat 13 5/8"

Wood Bottom Hem

- Wood bottom hems are available in two sizes:
1 1/4" high x 3/4" deep or 2" high x 5/8" deep.
- Available in 14 colors: Accessible Beige, Buckeye, Cottage Pine, Ebony Wash, Gardenia, Harmony, Java Roast, Mahogany, Moonshine, Natural, Navajo White, Revere Pewter, Snow White, Thunder. Sample chips are available using MySwatch.
- Maximum shade width is 60" for 1 1/4" Wood Bottom Hem.
- Maximum shade width is 72" for 2" Bottom Hem.
- Exclusions: EZ Lift; EZ Pull; Spring Roller; Fabrics Light-Vue, Luminescence



Wood Bottom Hem

Grommet Hem Style

- Grommets are 1 3/4" OS Diameter, 1 1/8" IS Diameter and spaced approximately 6" apart and 2" above hem.
- Select Grommet color from Genesis sample book. Grommet is polymer, available in 10 colors.
- Price this hem style using the Decorative Hem-Grommet row in the Hemline Surcharge table.



Grommets 265

- | | | |
|---------|-------------|--------|
| Black | Ivory | Pewter |
| Bronze | Matte Brass | Walnut |
| Granite | Natural | White |
| | Pecan | |

Sewn Hem or Unfinished Hem

- A sewn hem using a wood slat inserted into the pocket is available.
- Style 305, material hemmed to the street side is standard.
- Style 333, material hemmed to the room side is a no charge option.
- Style 300, Unfinished Hem, is a no charge option.



Sewn Hem 305

Heat Sealed Bottom Hem

- Ideal for a flat fabric finish on the bottom of the shade. It replaces the bottom bar with a concealed weighted pocket for a sleek look. This hem option is no charge.
- See [pages 62-63](#) for fabric availability.

Magnetic Hold Downs

- Metal is inserted at the ends of the bottom rail and hold down magnets are attached to the window frame to hold the bottom rail in place when the shade is lowered.
- Exclusions: Heat sealed bottom hem



Hold Downs

- An oval wooden rod is inserted into the hem pocket and a hole is drilled for the hold down bracket attachment.
- Hold downs must be specified at the time of the order and cannot be retrofitted in the field.

Design Options

Window Shades - Other Options

Bead Chains - Metal and Colored Metal

- Available on a clutch operated window shade.
- Finishes available: Stainless Steel, Antique Bronze, Gun Metal, Burnished Copper.
- To price add the stainless steel bead chain surcharge or the colored metal bead chain surcharge to the shade price.

Bead Chain Loop Substitution

- The bead chain loop can be substituted with one of the other standard bead chain loops available (see specification pages).
- A custom bead chain loop can be ordered as long as the length is greater than the length shown in the bead chain loop chart. All custom bead chain loops will have a connector.
- If a bead chain loop greater than 96" is desired, a connector will be added to the color coordinated bead chain loop.
- If ordering a custom bead chain length less than 2/3 the length of your shade, the connector may not allow full rotation. Bead chain lengths must be at least 4" shorter than window length for inside mounts to properly install tensioner.
- If an installer attempts to make a custom bead chain loop with a connector, it could prevent the shade from operating properly.

Decorative SL Clutch and Bracket Cover

- Available in Satin Nickel finish with a Stainless Steel Bead Chain.
- Only available for SL10 and SL20 clutches. See Clutch/Tube Chart on [page 68](#).



Flame Retardant (FR) Coating or Antimicrobial

- A flame retardant or antimicrobial coating is available for Genesis fabrics without these inherent properties. The shade is fabricated then sent to an external facility for the flame coating or antimicrobial process. Allow four to six weeks extra delivery time for this service. Standard shipping is included. Call for quote on flame retardant or antimicrobial coating.

Galaxy 400 Spring Assist Clutch System

- This Spring assist clutch reduces the pull force necessary on larger shades and is used on larger shade sizes. See Clutch/Tube Chart on [page 68](#).
- Shades in the same room with mixed clutch systems will operate differently. Optional upgrade to Galaxy clutch is available.
- Availability on cassette and fascia systems is clutch size dependent, not clutch type dependent.
- Minimum shade height is 54".



P Clip Safety Tensioner

- An option in place of a cord tensioner. The clear P-Clip has a torsion spring that will open the tensioner and prevents the chain from sliding through it. The tensioner will then render the shade partially inoperable if it is loose from the wall.

Tube Upgrades

- Varying shade sizes in one room may require upgrading to a larger tube size on some shades to maintain a uniform appearance. The tube upgrade charge will apply to each shade that would normally use a smaller tube size.

Genesis Arch or Angle

- See Genesis Roman Shade Arch or Angle on [page 73](#).

Palladian Window Shelf

- Double beaded hardwood shelf mounts horizontally in arched or angled openings to serve as divider and mounting surface for any window fashions product.
- Allows area above shelf to be treated independently.
- Finishes available from Woodland Harvest or Heartland Woods.
- Palladian shelf has a 1/32" per foot tolerance for warpage.
- Inside Mount Applications only.

Size Standards

- Height: 1 1/2"
- Depth: 4" (Can be cut down to 2" minimum upon request)
- Maximum Length: 8'

Ordering Notes

- Must be installed below the radius of window; routed ends are square
- Specify exact width from jamb to jamb. A 1/16" deduction is taken by Lafayette.
- Ordered separate from shade (Priced by lineal foot - round up from exact width to next highest lineal foot.)
- **Exclusions:** Outside mount applications

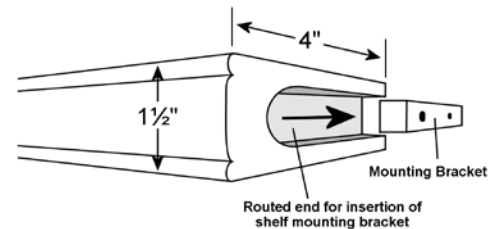

Dual Shade Bracket

- Genesis Dual Shades Brackets are only available as **Inside Mount** shades using a vertical dual bracket with an SL Series clutch.
- Maximum shade width is based upon fabric width or 103" (whichever is less); railroading is available for some fabrics.
- Maximum shade height is 96".
- Vertical dual bracket is 2" deep and 5 3/4" high. For a fully recessed installation, allow 2 1/2" or greater based on material thickness.
- The upper shade will have a reverse roll (rolls off on room side). The lower shade has a standard roll.
- The shades cannot have controls on the same side.
- To price, add the two shade prices together and add the Dual Shade Bracket surcharge.
- Exclusions: Cassette or Fascia systems.



Design Options

Window Shades - Bracket Information

Genesis Window Shade Brackets

Spring Roller

The type and size of bracket sent with a Genesis spring roller shade varies with the roller size and type of installation. Refer to the Lafayette Shade Products price list for a complete listing of spring roller bracket types and sizes.

SL Series Clutch

Brackets available in 3 projections
1/2" wide for all brackets

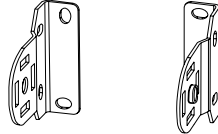

Item Numbers	Clutch	Projection	Height
10000-660360X	SL	1 1/2"	2 3/8"
10000-660380X	SL	2"	2 3/8"
10000-660590X	SL	2 7/8"	2 3/8"

(X = B for Black, W for White, V for Vanilla)

R Series Clutch

Brackets available in 3 projections
1/2" wide for all brackets

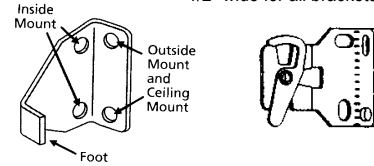

R Series Control Side

R Series Idler Side

Item Numbers	Clutch	Projection	Height
10000-560360	R3, R8	1 1/2"	1 1/2"
10000-560560	R16, R24	1 1/2"	1 1/2"
10000-560380	R3, R8	2"	2 1/2"
10000-560580	R16, R24	2"	2 1/2"
10000-560390	R8	2"	2 1/2"
10000-560590	R16, R24	2 7/8"	2 1/2"

R Series Mounting Requirements

• Inside Mount (IS) - Minimum Mounting Depth		
- R Series	1" Tube	1 3/4"
	2 1/2" & 3" Tube	3 1/4"
	All other	2 3/4"
• Inside Mount (IS) - Min Mounting Depth - Flush Mount		
- R Series	1" Tube	2"
	2 1/2" & 3" Tube	3 3/4"
	All other	2 3/4"
• Inside Mount (IS) - Min Mounting Depth - Wall Mount		
- R Series	All tubes	5/8"
• Outside Mount (OS) - Minimum Flat Vertical Surface		
- R Series	1" tube	1 1/2"
- R Series	All other	2 1/2"

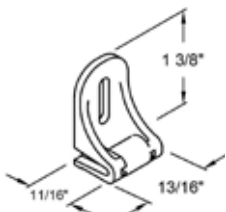
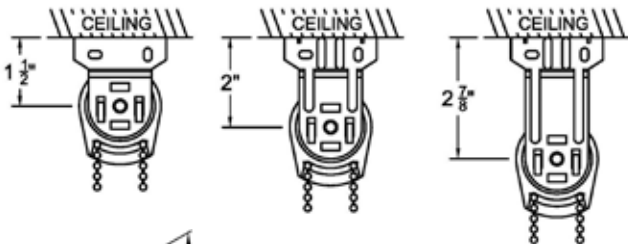
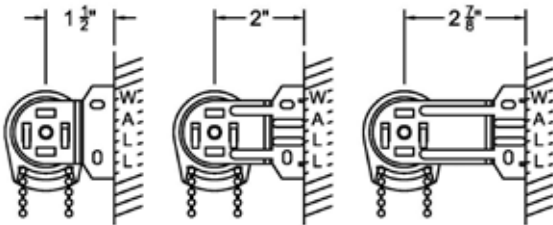
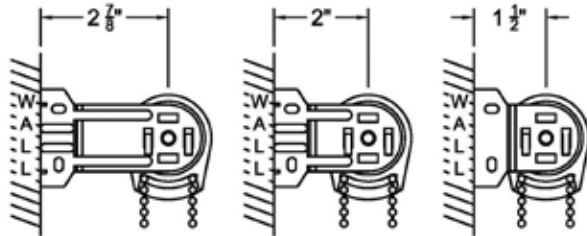

Magnetic Hold Down Bracket
Item # 15-9108

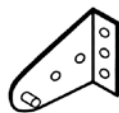

Hold Down Bracket
Item # WWC-900205

Small and Large Cassette Brackets

Small Cassette - Item 80-30053-XX

Colors: 03 Black, 09 Vanilla, 11 White, 38 Bronze, 53 Sierra Tan, 90 Bright Zinc.

Large Cassette - Item 10000-UBC660

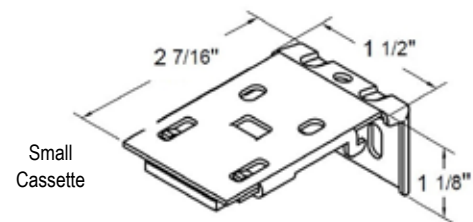

Small Cassette

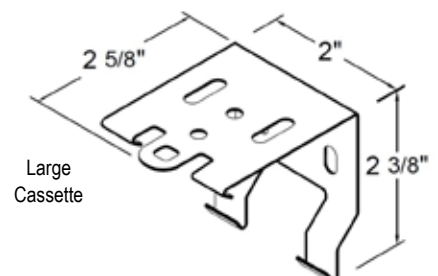

Large Cassette

Window Shades - Clutch and Tube Sizes

- Roller tube size (diameter) is determined based on shade width and length.
- Small Cassette, Large Cassette, Luxe Decorative Clutch and EZ Lift, EZ Pull, and Sure-Lift systems utilize a 1 1/2" aluminum tube.
- SL10, SL20, SL30 = Clutch (R8, R16, R24 with stationary idle end available upon request).
- We HIGHLY recommend upgrading to the G400 Spring Assist Clutch to for shade sizes shown in the area with gray shading.
- The G400 is a spring assist clutch and included on the shade sizes shown.
- Varying shade sizes in one room may require upgrading to a larger tube size on some shades to maintain a uniform appearance.
- The tube upgrade surcharge applies to each shade that would normally use a smaller tube size. Tube upgrade surcharges are on [page 30](#).

Shade Width Up To:	54"	72"	96"	109"	133"	144"	168"	174"	192"	
Shade Height Up To:	48"	SL10 - 1"	SL10 - 1 3/8"	SL20 - 1 3/8"	SL20 - 2"	SL30 - 2"	SL30 - 2 1/2"	SL30 - 3 1/4"	SL30 - 3 1/4"	SL30 - 3 1/4"
	60"	SL10 - 1"	SL10 - 1 3/8"	SL20 - 1 3/8"	SL20 - 2"	SL30 - 2"	SL30 - 2 1/2"	SL30 - 3 1/4"	SL30 - 3 1/4"	SL30 - 3 1/4"
	70"	SL10 - 1"	SL10 - 1 3/8"	SL20 - 1 3/8"	SL20 - 2"	SL30 - 2"	SL30 - 2 1/2"	SL30 - 3 1/4"	SL30 - 3 1/4"	SL30 - 3 1/4"
	72"	SL10 - 1"	SL10 - 1 3/8"	SL20 - 1 3/8"	SL20 - 2"	SL30 - 2"	SL30 - 2 1/2"	SL30 - 3 1/4"	SL30 - 3 1/4"	SL30 - 3 1/4"
	78"	SL10 - 1"	SL10 - 1 3/8"	SL20 - 1 3/8"	SL20 - 2"	SL30 - 2"	SL30 - 2 1/2"	SL30 - 3 1/4"	SL30 - 3 1/4"	SL30 - 3 1/4"
	84"	SL10 - 1"	SL10 - 1 3/8"	SL20 - 1 3/8"	SL20 - 2"	SL30 - 2"	SL30 - 2 1/2"	SL30 - 3 1/4"	G400 - 3 1/4"	G400 - 3 1/4"
	96"	SL10 - 1 3/8"	SL10 - 1 3/8"	SL20 - 1 3/8"	SL20 - 2"	SL30 - 2"	SL30 - 2 1/2"	SL30 - 3 1/4"	G400 - 3 1/4"	G400 - 3 1/4"
	108"	SL20 - 1 3/8"	SL20 - 1 3/8"	SL20 - 2"	SL20 - 2"	SL30 - 2 1/2"	SL30 - 2 1/2"	SL30 - 3 1/4"	G400 - 3 1/4"	G400 - 3 1/4"
	120"	SL20 - 1 3/8"	SL20 - 1 3/8"	SL20 - 2"	SL30 - 2"	SL30 - 2 1/2"	SL30 - 2 1/2"	SL30 - 3 1/4"	G400 - 3 1/4"	G400 - 3 1/4"

Window Shades - Measuring and Operation

Best Practices for Measuring

- Always use a steel tape or a metal ruler for measuring.
- Always measure every window even though they look the same.
- Check for obstructions that could affect operation of the shade.
- For Inside Mount (jamb to jamb in a window or door, wall to wall in a room), give exact inside to inside width measurements, and top to bottom length measurements of the area to be covered.
- For Inside Mount, measure the width where the brackets will be installed.
- Measure the length in at least three places and specify the shortest length.
- Take two diagonal measurements. If the difference in the diagonal measurements is greater than 3/8", an outside mount is strongly recommended to avoid light gaps.
- For Outside Mount, measure the exact width and height of the area to be covered.
- For Cloth Measure measurement, the area to cover is given. The overall finished shade width will increase when ordering by the Cloth Measure.

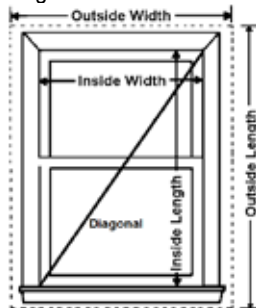

Operation and Adjustments

- Make sure the brackets are mounted level or the shade will roll up crooked.
- Remove slat from hem pocket before installing plastic hem grip to avoid damaging material. Then, carefully slide slat inside hem.
- Always pull spring roller shades from the center. Pulling the shades from the side can cause the shade to roll crookedly and possibly damage the edges.
- If the shade does not roll straight, correct as follows: Place 1 to 2 layers of tape (4" to 6" long) on opposite side that the material is skewing, horizontally on the tube.
- Adjusting spring roller shade for roller tension: When shade does not roll up, the spring is too loose. To adjust:
 1. Draw shade about 18" and remove from brackets.
 2. Roll up shade by hand and replace in brackets. Repeat until proper tension is reached.
- When shade will not stay down, the spring is too tight. To adjust:
 1. Raise shade all the way up and remove from brackets.
 2. Unroll the shade about 18" and replace in brackets. Repeat until proper tension is reached.

Window Shade Measuring

- All shade pricing is based on the width and the window opening height.
- Custom shade orders are accepted for either inside mount, outside mount or Cloth Measure.
- Custom shade width measurements should be taken to the nearest 1/16".
- It is critical that the shade brackets are mounted level so that the shade is level when installed.
- For Height, measure the full length of the window opening from the top frame to the lower sill (or bottom coverage point) to determine your window height.
- For Cloth Measure measurement, the area to cover is given. The overall finished shade width will increase when ordering by the Cloth Measure.
- Finished Dimensions are given on the product specification pages.

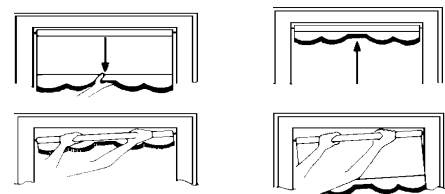

Fabric Care and Cleaning

- Shade fabrics can be cleaned periodically using a vacuum with a soft bristle attachment.
- Shade fabrics with fiberglass or PVC can usually be wiped gently with mild detergent. We recommend testing a small area prior to cleaning the entire shade. For shade fabric content refer to the Genesis Technical specifications found in the Dealer Center under Product Information/Genesis.
- Ultrasonic cleaning is not recommended.

Product Information

Shade Masterpieces and COM Window Shades

Shade Masterpieces™

- Lafayette will laminate suitable fabrics from its comprehensive Select Masterpieces® collection for custom window shades.
- Choose Translucent (Fiberlucet) or Opaque (No Lite Fiberglass) shade cloth opacity for laminated backing.
- Find the Price Group for the Shade Masterpieces Custom Shade from the Lafayette Fabric Index. The Select Masterpieces Price Group given in the Fabric Index is EQUAL to the Price Group number for the Genesis Shade Masterpieces pricing tables.
- Certain Select Masterpieces fabrics are not suitable for Custom Window Shades. If the Select Masterpieces fabric sample swatch contains a window shade icon on the bottom strip then the fabric is suitable for Shade Masterpieces. The Lafayette Fabric Index also shows whether a fabric is available as a Shade Masterpiece.
- A SL Series Clutch Roller system is standard on all Shade Masterpieces and included in the price. The clutch system allows for easy operation.
- Large Cassette, 4" Fascia and Tube Size Upgrades are available as Design Options. Gimps are shown in the Genesis sample book.
- Shade edges are serged to protect the fabric from fraying.
- Shade Masterpieces use a flame retardant backing, therefore a flame retardant fabric made into a Shade Masterpiece will retain its flame retardant properties.
- Lafayette will seam fabrics for laminated shades when the Cloth Measure of the shade exceeds the maximum width of the fabric itself (and the fabric is suitable for seaming). Note that seams are VISIBLE. Where a seam is required, there will be two vertical seams and three segments. If seamed, the middle segment will be a full width of fabric and the two outer segments will be equal sizes.
- Room Darkening backing is suggested for laminated shades when any type of seaming is required.

Ordering Notes

- Exclusions: Reverse Roll Shades

COM Procedures

- Place product order first before purchasing or shipping the COM fabric to Lafayette. Note the Pick-up Number, Reference Number and Agent's name.
- Include the Pick-up Number, your company name and account number on the outside of the COM shipping package. COM Fabric Shipping Labels (Form #18-7099-02) are available at no charge. If **EACH** roll is not properly identified the roll is **refused in receiving and returned to the place from which it was sent**.
- On each fabric inside of the package, include your account number, the reference number, pattern name and color, and indicate fabric face side.
- Allow more time. COM fabrics require shipping time from COM fabric mill to you and then shipping time from you to Lafayette. Once it arrives at Lafayette it is double inspected before being released into production.



COM Window Shades

- The Select Masterpieces fabric collection contains an extensive array of decorative fabrics for the home. But occasionally a client will have a need for a fabric which cannot be satisfied with Lafayette's fabric offering. For those situations we do allow COM fabrics to be sent in for Custom Window Shades.
- An SL Series Clutch Roller is standard on all COM Window Shades and included in the window shade price. A Large Cassette System is available for a surcharge.
- Customer must specify room darkening or light filtering backing material. Select Light Filtering lining in White, Oyster or Eggshell; Room Darkening lining in White, Oyster or Light Ivory.
- Lafayette will seam fabrics for COM shades when the Cloth Measure of the shade exceeds the maximum width of the fabric itself (and the fabric is suitable for seaming). Note that seams are VISIBLE. Where a seam is required, there will be two vertical seams and three segments. If seamed, the middle segment will be a full width of fabric and the two outer segments will be equal sizes.
- Room Darkening backing is suggested for laminated shades when any type of seaming is required.

Size Limits

- Maximum width with fabric seamed vertically using room darkening backing, Clutch or Large Cassette: 78"
- Maximum width with fabric seamed vertically using light filtering backing, Clutch or Large Cassette: 72"
- Maximum width, when either backing is railroaded: 95"
Room darkening backing is railroaded to a max. window height of 68"; Light filtering backing is railroaded to a max. window height of 62".
- Minimum shade width is 15"; Minimum window height is 24".
- Maximum window height using a clutch is 96";
- Maximum window height using a cassette is 84".

Cautions

- Fabric must be sent to Lafayette rolled.   Folded fabric will not be accepted.
- Dealer should inspect all fabrics before shipping to Lafayette. We do not take responsibility for the customer's fabric. Lafayette's liability limit for COM fabrics shall not exceed the dealer fabric cost of \$25 per yard.
- Unique or irreplaceable fabrics should not be laminated.
- A small percentage of fabrics (approx. 2%) reject the lamination process even though they appear to be fabrics that should laminate. It is impossible to identify these fabrics before the product is manufactured. Lafayette will make every attempt to fix the problem. If it cannot be fixed, Lafayette will credit the shade if it is reordered in a different fabric.
- Prints that have a half drop repeat are difficult to match and require additional yardage.

Ordering Notes

- Exclusions: Reverse Roll Shades, Fabrics greater than 54" wide, Solid fabrics, Vertical or horizontal stripes and plaids.
- See COM Procedures for fabric pickup information.

Product Information

Flat Roman Shades

Product Features

- Fits rectangular window openings
- Available on many Genesis fabrics; [See pages 3-4.](#)
- Traditional style: Headrail projection of 2" ($\pm 1/8$ "); Valance and cord lift system to front of shade
- Folds are spaced approximately 7" apart.
- Flat self-valance hangs approx. 7" off the headrail with cords behind the valance.
- Clear polymer rods on the back of shade provide folds (N/A on Tahiti)
- Tahiti shades utilize brass rings in the back of the shade to form the folds.
- Controls on the right side are standard.
- Pull cord and cord lock are placed in front of the material (and behind the valance) for easy access.
- TLC Cord sleeve is 1.4 mm and color coordinated.
- Headrail is covered with fabric; The end of the headrail is wrapped for OS mount shades.

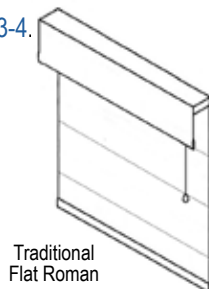

Traditional Flat Roman

Mounting Requirements

- Inside Mount (IS)
 - Minimum Mounting Depth: 1 1/2"
 - Mounting Depth, flush mount, standard: 2"
 - Mounting Depth, flush mount, CareRING Cordless: 2 1/2"
 - Mounting Depth, flush mount, Quick Lift Clutch: 2 1/2"
 - Mounting Depth, flush mount, Traditional Clutch: 2"
- Outside Mount (OS)
 - Minimum Flat Vertical Surface, standard: 1 1/2"
 - Minimum Flat Vertical Surface, CareRING Cordless: 1 9/16"
 - Minimum Flat Vertical Surface, Clutch: 1 9/16"

Finished Dimensions

For Cord Lock, Clutch and CareRING Cordless Lifting System

- Inside Mount (IS)
 - Fabric Width and Board Width: -1/2" (1/4" each side)
 - Shade Height: Ordered Height
- Outside Mount (OS)
 - Fabric Width: Ordered Width
 - Shade Height: Ordered Height
- 2-on-1 Headrail Center Gap: 1/2"

Size Standards

See Size Standards on [page 23.](#)

Approximate Stacking Height

When planning for an installation, the approximate amount of stacking height for a shade drop may be required. Use the information below as a GENERAL GUIDELINE ONLY. **Stacking height will vary based upon material thickness and weight for individual fabrics.**

30" Shade Drop - 9"	72" Shade Drop - 11"
48" Shade Drop - 9 3/4"	96" Shade Drop - 12 1/2"

Important Child Safety Note

In order to comply with the ANSI approved Standard For Safety of Window of Window Covering Products all supplied cord tension/locking devices or cord cleats must be properly installed.

Hardware Included

- Installation Brackets
- Cord Tension Lock with Clutch system

Options

- No Charge
 - Quick Lift Clutch system (Turned Headrail not available)
 - Traditional Clutch system (Turned Headrail not available)
 - Contemporary style:
 - Headrail projection of 2" ($\pm 1/8$ ");
 - Material off front and cord to back with valance
 - Turned Headrail - Traditional style:
 - Headrail projection of 1";
 - Valance and cord lift system to front of shade
 - Turned Headrail - Contemporary style:
 - Headrail projection of 1";
 - Cord to back of shade, valance
 - Hold Down Brackets
 - Optional Cord Lengths
 - Control Side (Left)



Contemporary Flat Roman

- Surcharge
 - Banding on Dakota, Tahiti and Yellowstone fabrics
 - Bottom Hem - Decorative Gimp (Winchester style 112 only)
 - CareRING Cordless Lifting System
 - Lining on Tahiti and Yellowstone fabrics
 - Motorization - [Pages 43-47](#)
 - Specialty Shapes: Angle Top, Arch Top, Arch, Angle
 - Top Down/Bottom Up (Turned Headrail not available)
 - Valance Length Addition of 6"

Ordering Notes

- The standard valance and cord lift system is **strongly recommended** for inside (jamb to jamb) installations.
- A clutch system on an inside installation WILL have a light gap.
- Roman shades with the same length will appear spearlined.
- Serging of the side edges is done on fabrics Beatty, Fedora, Hombre, Rocky Mountain, and Strie to help reduce fraying.

Caution

- Folds may appear very full and when in the raised position creases will form on the shade fabric.
- For natural patterns such as Beatty, Dakota, Fedora, Hombre, Rocky Mountain, Tahiti, and Yellowstone, **there will be imperfections that will be visible.** Some natural patterns offer slight differences in grain and texture, especially in materials containing knots or slight surface cracks. The finest native materials in shades contain some variations in color and hue. In addition, natural materials can have a slight bow or camber so that horizontal lines or bottom hems might not be perfectly straight. Fold alignment can vary slightly, even on shades that are the same height. Shades made of natural materials tend to stretch slightly over time.

Product Information

Flat Roman Shades - Child Safety and CareRING Cordless

TLC Roman Shade Child Safe System

- Child safety design standard on all Genesis Roman Shades.
- Our TLC child safe system completely encloses the rear traveling lift cords inside a protective sleeve. The sleeves are anchored along the back of the shade to confine the cord and eliminate the possibility of dangerous cord loops.
- Protective sleeve available in natural, camel, gray, and bronze.
- Operates on lined or unlined roman shades.
- Lafayette's TLC system has been tested by a Consumer Products Safety Commission (CPSC) approved independent laboratory and passed the provisions cited in the American National Standards Institute (ANSI/WCMA A100.1-2010).



CareRING Cordless System

- Unique cordless child safety design available on Genesis Roman Shades.
- Available on Traditional and Contemporary style roman shades. Inside mount shade has no returns with a 7" long back valance standard. Outside mount shade has 7" long returns and an optional 7" back valance by request at time of order.
- For widths 18 1/2" to 26 1/2", shades are available up to 56" long.
- For widths 26 5/8" to 78", shades are available up to 84" long.
- CareRING and stop ball are anodized aluminum finish and are attached to the back of the cordless shade.
- Available as Multiple Shades on One Headrail. Add CareRING Cordless width-based surcharge for each shade.
- For inside mount, 3" screws are included.
- For outside mount, L brackets are included.
- Exclusions: Banding (Dakota, Tahiti, Yellowstone), Top Down/Bottom Up, Specialty shape shades
- CAUTION: Do not over-rotate or shade does not roll up.



CareRING Cordless Raised

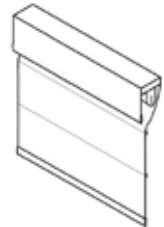

Cord Tension Lock

- Standard on all Genesis Roman Shades with a Clutch system.
- The Cord Tension Lock must be secured to the wall to provide the necessary tension for the shade to operate.
- The Cord Tension Lock is available in white, vanilla, black, brown, clear, or gray. Tension lock and continuous bead chain match each other and coordinate with the fabric color. **Sierra Tan cord uses a clear cord tension lock.**
- Clutch system will be inoperable if the Cord Tension Lock is not secured.
- Cord Tension Lock is an additional precaution designed to protect children and pets.

The horizontal lines on the Cord Tension Lock show where the screw should be tensioned. If the tensioner is not set at the level suggested then the tension will be too tight and the cord may break.



⚠ WARNING

Young children can STRANGLE in cord and bead chain loops. They can also wrap cords around their necks and STRANGLE.

- Always keep cords and bead chains out of children's reach.
- Move cribs, playpens and other furniture away from cords and bead chains. Children can climb furniture to get to cords.
- Do not tie cords together. Make sure cords do not twist together and create a loop.

* Lafayette Interior Fashions strongly recommends installing all provided safety hardware.

P Clip Safety Tensioner

- An option in place of a cord tensioner. The clear P-Clip has a torsion spring that will open the tensioner and prevents the chain from sliding through it. The tensioner will then render the shade partially inoperable if it is loose from the wall.

Product Information

Flat Roman Shades - Specialties

Top Down/Bottom Up Shade

- Fits rectangular window openings
- Front valance and cord lock system. Back valance is an option.
- See Size Standards on [page 23](#).
- 2" deep x 1" high headrail

Ordering Notes

- Tahiti and Yellowstone Top Down/Bottom Up shades with the flat lining option must also be banded.
- Folds may appear very full on some fabrics and when in the raised position creases will form.
- Exclusions: Clutch system

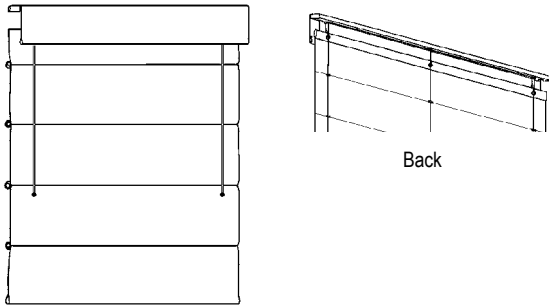

Angle Top Flat Roman Shade

- Fits window openings with a sloped top board; specify short point height and side (left or right) and long point height. **A diagram is required.**
- Shade operates as standard rectangular cord lock, shade raises only to the bottom of the angle.
- See [page 23](#) for Size Standards and product availability.
- Maximum angle of slope is 35°
- Self-valance and cord lift system with cord to the front of shade
- Material is secured to a 1" or 2" projection board with staples; staples are hidden using gimp.
- Shade valance is 6 1/2" long at the shortest point of slope; Cord lock is on the short side of the angle.
- If a lined angle top flat roman shade is ordered then the lining extends into the angle.
- L-brackets for easy installation

Ordering Notes

- Price shade using long side as height, then add the Angle Top surcharge.
- Exclusions: Angle Bottom, Clutch system

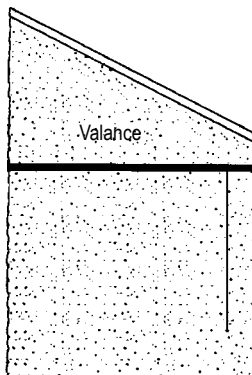

Online Template Service

- A template can assure an accurate fit for arched or angle windows.
- Visit the Lafayette web site at www.lafayetteinteriorfashions.com to order a Lafayette produced template for a flat fee.

Arch Top Flat Roman Shade

- Fits window openings with an arched top opening. **Template is required.**
- Shade operates as standard rectangular, shade raises only to the bottom of the arch top.
- See [page 23](#) for Size Standards and product availability.
- Arch height cannot exceed 1/2 of the arch width.
- 2" deep x 1" high headrail
- Material is secured to a 3/4" projection wooden frame with staples, staples are hidden using gimp around the arch top edge.
- Choose self-valance or no valance; Flat valance length is approx. 7" longer than the bottom of the arch portion; cord controls can be on either side of shade.
- If a lined arch top flat roman shade is ordered then the lining extends into the arch.
- L-brackets for easy installation

Ordering Notes

- Price shade using highest point of arch to bottom height, then add the Arch Top surcharge.
- Exclusions: Clutch system

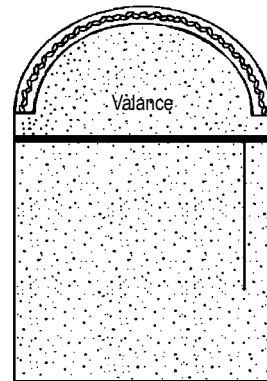

Arch Top Shade off back with Valance off front (Standard)

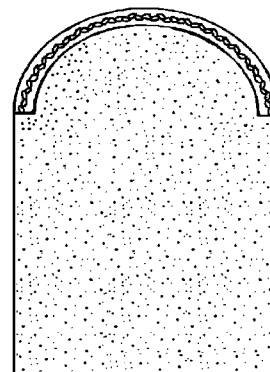

Arch Top Shade off front Valance to the back

Product Information

Flat Roman Shades - Specialties

Roman Arch

- Roman Arch is stationary.
Template is required.
- Pattern runs horizontally.
- See [page 23](#) for Size Standards and product availability.
- Arch height cannot exceed $\frac{1}{2}$ of the arch width.
- Standard Arch - Board depth is $\frac{7}{8}$ "; Board height is 2".
- Framed Arch - Frame depth is 1"; Frame height is $1\frac{5}{8}$ ".
- Routed Framed Arch - Frame depth is 1"; Frame height is 2".
- Material is secured to the front of a wooden frame with staples, staples are hidden using gimp.
- Button catches are sent for installation
- Price shade using highest point of arch to bottom height, then add the Arch surcharge. Framed and Routed Framed Arch are also available for a surcharge.
- Framed or Routed Framed Arch are available in 14 colors: Accessible Beige, Buckeye, Cottage Pine, Ebony Wash, Gardenia, Harmony, Java Roast, Mahogany, Moonshine, Natural, Navajo White, Revere Pewter, Snow White, Thunder. Sample chips are available using MySwatch.



Arch Shade with no frame



Arch Shade with frame

Roman Angle

- Roman Right Angle Triangle or Isoceles Triangle is stationary.
Template or diagram is required.
- Pattern runs horizontally.
- See [page 23](#) for Size Standards and product availability.
- Triangle height cannot exceed $\frac{1}{2}$ of the triangle width.
- Standard Triangle - Board depth is $\frac{7}{8}$ "; Board height is 2".
- Framed Triangle - Frame depth is 1"; Frame height is $1\frac{5}{8}$ ".
- Routed Framed Triangle - Frame depth is 1"; Frame height is 2".
- Material is secured to the front of a wooden frame with staples, staples are hidden using gimp.
- Button catches are sent for installation
- Price shade using highest point of angle to bottom height, then add the Arch/Angle surcharge. Framed and Routed Framed Triangles are also available for a surcharge.
- Framed or Routed Framed Arch are available in 14 colors: Accessible Beige, Buckeye, Cottage Pine, Ebony Wash, Gardenia, Harmony, Java Roast, Mahogany, Moonshine, Natural, Navajo White, Revere Pewter, Snow White, Thunder. Sample chips are available using MySwatch.



Triangle with no frame

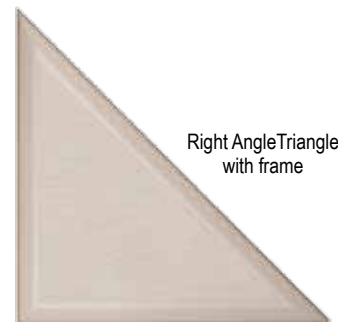

Right Angle Triangle with frame



Triangle with frame

Design Options

Flat Roman Shades

Clutch Systems

- Choose from Quick Lift Clutch System or Traditional Clutch System. Both systems use continuous bead chain loop with Cord Tension Lock.
- Traditional style shade: cord loop and clutch are in front of the shade behind the valance.
- Option: Contemporary style with cord loop and clutch behind the shade and optional back valance.
- See [page 23](#) for Size Standards and product availability.
- See Continuous Bead Chain Drop Chart below.
- Exclusions: Turned Headrail, Specialty Roman Shades

Shade Length	Drop	Shade Length	Drop
Up to 22"	12"	54 1/16" - 66"	48"
22 1/16" - 27"	18"	66 1/16" - 78"	60"
27 1/16" - 39"	24"	78 1/16" - 90"	72"
39 1/16" - 42"	36"	90 1/16" - 102"	84"
42 1/16" - 54"	39"	Over 102"	96"

*Note: Custom lengths or lengths longer than 96" will have a connector.

Quick Lift Clutch

Minimum width 15".
Shade raises and lowers faster than the Traditional Clutch System.
Board has a 2 1/2" return.



Traditional Clutch System

Minimum width 24"
2" deep x 1" high headrail;
Return size is 2".
Shade can be raised to a precise height with minimal effort.



Clutch System Ordering Notes

- For Outside Mount clutch system shades, the headrail and valance measure 3/4" greater than than the ordered width. This allows the Cord Tension Lock and Clutch to line up vertically with no contact with the material edge (see illustration). If a wrapped end is ordered, the valance will measure an additional 1/4" due to material thickness.

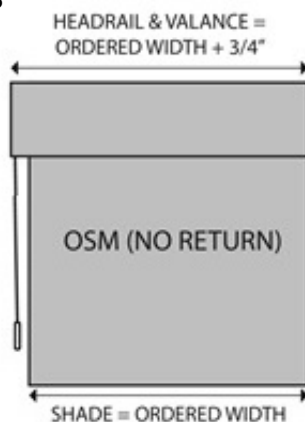

Flat Lining for Tahiti & Yellowstone

- Shade can be lined with high quality polyester/cotton lining. Choose light filtering or room darkening, in white or ivory.
- Lining is inset approximately 1/4" from the edge of the shade material with serged edges on each side.
- Lining has brass rings for cord raising/lowering.
- Lining may need to be "dressed". This helps to train the lining to fall into the folds.
- Multiple Shades on One Headrail: Lining surcharge is per shade.

Banding for Dakota, Tahiti & Yellowstone

- Select 1 1/4" or 3" solid banding from the on-line Materials Library.
- Edge Banding is available in fabric or twill banding.
- For 1 1/4" banding, 5/8" banding shows on each side.
- For 3" banding, 1 1/2" banding shows on each side.
- The sewing standard for a corner is the vertical band covering the horizontal band.
- Edge Banding can be combined with lining option.
- Six banding configurations are available:

Valance Hem/Bottom Hem (VBH2)



Valance Sides/Shade Sides (VSS2)



Sides/Bottom Hem (SBH3)

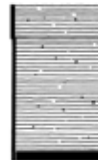

Both Sides and Hems (BSH4)

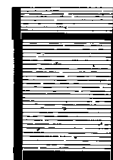

Valance Sides Only (VOS2)



Valance Sides and Hem Only (VOB3)

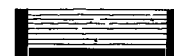

Ordering Notes

- Bottom Hem Banding: Bottom Hem has 3" banding, even if the shade has 1 1/4" banding.
- Edge Banding shows on the bottom hem even when shade is raised.
- Multiple Shades on One Headrail: Banding surcharge is per shade. The valance will not align vertically with the banding on the adjacent shade due to the 1/2" gap between the shades
- For Arch top shades the only banding configuration available is Valance Hem/Bottom Hem (VBH2)
- Exclusions: Hold Down Brackets, CareRING Cordless



Decorative Hem

- Refer to [pages 3-4](#) to determine whether a fabric is available with a Decorative Hem.
- Winchester 112 is the only hem style available - [Page 65](#).
- Gimp is available in the following colors:

Baltic	Brandy	Camel	Ivory	Sandstone
Black	Brown	Gold	Moss	White

Product Information

Roman Shades - Design Options, Measuring and Brackets

Turned Headrail

- Projection is 3/4".
- Only available with Cordlock system.
- The 2" board is turned on its edge and hardware is installed. This allows the shades to be installed in shallow window openings and also provides a low profile installation on doors.

Multiple Shades on One Headrail

- Minimum width of a cord lock shade is 11"; Maximum headrail width is 192" for any combination of multiple shades on one headrail.
- For multiple shades on one headrail using the clutch system, the minimum single shade width is 24"; Max. width is fabric dependent.

Ordering Notes

- Price each shade separately then add the multiple headrail surcharge.

Hold Down Brackets

- An oval wooden rod is inserted into the hem pocket at the bottom of the shade and a hole is drilled for the hold down bracket attachment.
- Hold down brackets are not available with banding option.
- Hold downs must be specified at the time of the order and cannot be retrofitted in the field.

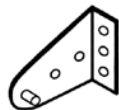

Hold Down Bracket
Item # WWC-900205

Palladian Window Shelf

- Double beaded hardwood shelf mounts horizontally in arched or angled openings to serve as divider and mounting surface for any window fashions product.
- Allows area above shelf to be treated independently.
- Finishes available from Woodland Harvest or Heartland Woods.
- Palladian shelf has a 1/32" per foot tolerance for warpage.
- Inside Mount Applications only.

Size Standards

- Height: 1 1/2"
- Depth: 4" (Can be cut down to 2" minimum upon request)
- Maximum Length: 8'

Ordering Notes

- Must be installed below the radius of window; routed ends are square
- Specify exact width from jamb to jamb. A 1/16" deduction is taken by Lafayette.
- Ordered separate from shade (Priced by lineal foot - round up from exact width to next highest lineal foot.)
- **Exclusions:** Outside mount applications

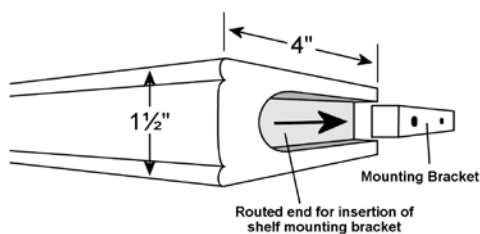

Best Practices for Measuring

- Always use a steel tape or a metal ruler for measuring.
- Always measure every window even though they look the same.
- Check for obstructions that could affect operation of the shade.
- For Inside Mount (jamb to jamb in a window or door, wall to wall in a room), give exact inside to inside width measurements, and top to bottom length measurements of the area to be covered.
- Measure the width in at least three places and specify the narrowest width.
- Measure the length in at least three places and specify the shortest length.
- Take two diagonal measurements. If there is a greater than 3/8" difference in diagonal measurements, outside mount is strongly recommended to avoid irregular light gaps.
- For Outside Mount, measure the exact width and height of the area to be covered.

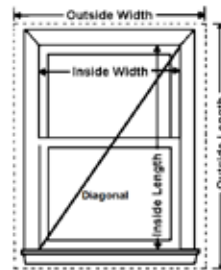

Roman Shade Measuring

- All shade pricing is based on the width and the height.
- Roman shade orders are accepted for either inside or outside dimensions.
- Shade width measurements should be taken to the nearest 1/16".
- It is critical that the shade brackets are mounted level so that the shade is level when installed.
- Check the projection of the style of roman shades ordered to determine minimum recess.
- For an Inside Mount, we STRONGLY recommend the Traditional style that has the cord and cord lock in front of the material for easy access.
- For Length, measure the full length of the window opening from the top frame to the lower sill (or bottom coverage point) to determine your window length.
- Finished Dimensions are given on [page 70](#).

Roman Shade Brackets

- The type of bracket and size of bracket sent with a roman shade order is dependent on the valance or no valance option specified
- Inside Mount shades are shipped with 3" screws.
- Outside Mount shades are shipped with a New York Style bracket.
- CareRING Cordless shades are shipped with L bracket (PT-SV29).
- Spacer blocks are available if more projection is required (Item SP-31).

New York Style Bracket
Outside Bracket RWC-60025
Ceiling Bracket RWC-60026

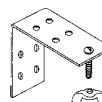

Button Catch for Arch
Receiver - Item # B0-07000-034
Catch - Item #702664
Screw - Item TFP-04051-034



Product Information

Panel Track

Product Features

- Fits rectangular window openings
- Available on many Genesis fabrics; See [pages 3-4](#).
- One Way Draw or Split Draw
- Cord Draw or Wand Control; Wand Control with Split Draw has 2 wands; Wand is clear acrylic
- Split Draw with cord draw always uses a 5 channel track
- Front Panel Draw is standard (panels stack in front of each other with fixed panel closest to the window side).
- Track system is .045" thick aluminum with White, Black, Satin Nickel or Pewter.
- Track can be ceiling mounted or wall mounted
- Track has integrated hook and loop system for easy panel attachment
- Approximate 3" panel overlap provides uniform view and minimizes light leakage.
- Aluminum bar is inserted into bottom hem
- Installation Bracket and Swivel Bracket are color coordinated to the track color. Black brackets are sent with Pewter track finish.

Mounting Requirements

- Inside Mount (IS)
 - Minimum Mounting Depth
 - 3 Channels: 1 7/8"
 - 4 Channels: 2 1/4"
 - 5 Channels: 3"
 - Minimum Mounting Depth, flush mount
 - 3 Channels: 2 1/4"
 - 4 Channels: 2 7/8"
 - 5 Channels: 3 5/8"
- Outside Mount (OS)
 - Minimum Flat Vertical Surface: 5/8"

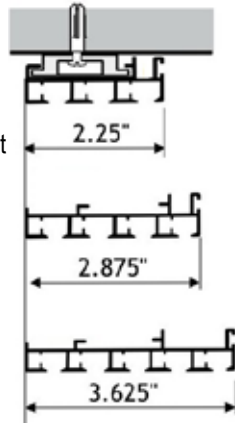

Finished Dimensions

- Inside Mount (IS)
 - Overall Fabric Width - Cord Draw: - 3/4" (3/8" on each side)
 - Overall Fabric Width - Wand Draw: - 1/4"
 - Shade Height: -3/8"
 - Track Width for Cord Draw: Ordered width - 1/8"
 - Track Width for Wand Draw: Ordered width - 1/8"
- Outside Mount (OS)
 - Overall Fabric Width: Ordered Width
 - Shade Height: Ordered Height
 - Track Width for Cord Draw: Ordered width + 1"
 - Track Width for Wand Draw: Ordered width + 1/8"

Approximate Panel Size

See table on [page 78](#) for approximate panel size.

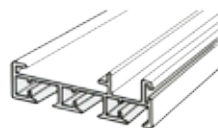

3 Channel

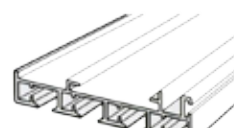

4 Channel

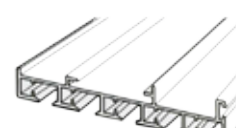

5 Channel

Size Standards

- Maximum headrail width is 192"
- Cord Draw is available up to 144" length
- Wand Control is available up to 96" length; Shades less than 7' long have a 36" wand standard; Shades 7' or greater have a 48" wand standard
- Minimum height of shade is 39" for wand draw
- Minimum height of shade is 24" for cord draw

Important Child Safety Note

The revised American National Standard for Safety of Corded Window Covering products requires if corded window products are used in the home, cord cleats or cord tension locks must be properly installed.

Hardware Included

- Installation Brackets (L Brackets for OS Mount)
- Cord Tensioner Bracket with Cord Draw

Options

- No Charge
 - Back Draw Panel - Panels stack in back of each other with the fixed panel closest to the ROOM side
 - Wand Length (36" or 48")
- Surcharge
 - Artisan Valance
 - Majesty Valance, Noble 4 5/8" Valance, or Camelot Valance

Ordering Notes

- For windows greater than 192", a splice kit can be requested or tracks may be butted but panels will not meet.
- Serging of the side edges is done on Beatty, Fedora, Hombre, Rocky Mountain and Rollie to help reduce fraying.

Caution

- For natural patterns such as Rocky Mountain and Yellowstone, **there will be visible imperfections.** Some natural patterns offer slight differences in grain and texture, especially in materials containing knots or slight surface cracks. The finest native materials in shades contain some variations in color and hue. In addition, natural materials can have a slight bow or camber so that horizontal lines or bottom hems might not be perfectly straight. Fold alignment can vary slightly, even on shades that are the same height. Shades made of natural materials tend to stretch slightly over time.

Product Information

Panel Track Configurations

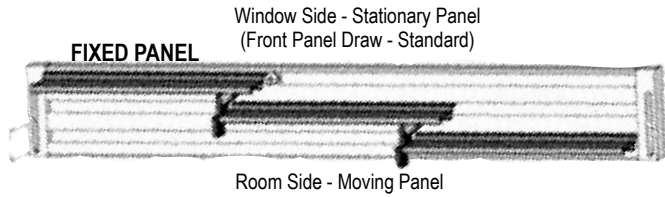

- 3 Channels - One Way Draw
 2 Panels
 For 2 panel systems one channel is empty
 2 Panels - Minimum Track Width is 27"
 2 Panels - Maximum Track Width is 79"
 Number of Overlaps: 1
 3 Panels
 3 Panels - Minimum Track Width is 39"
 3 Panels - Maximum Track Width is 117"
 Number of Overlaps: 2

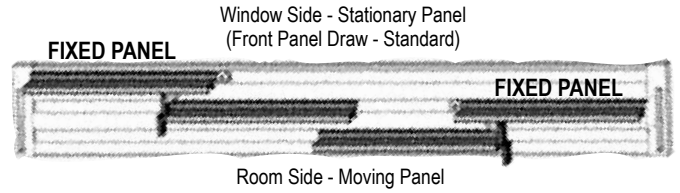

- 3 Channels - Split Draw - Wand Control
 4 Panels
 Minimum Track Width is 51"
 Maximum Track Width is 155"
 Number of Overlaps: 3

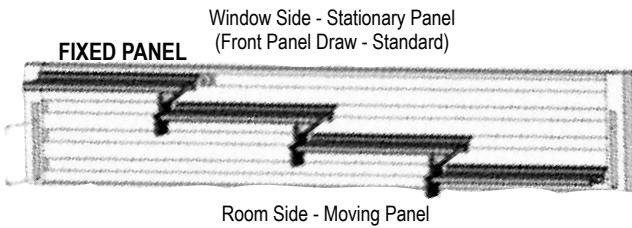

- 4 Channels - One Way Draw
 4 Panels
 Minimum Track Width is 51"
 Maximum Track Width is 155"
 Number of Overlaps: 3

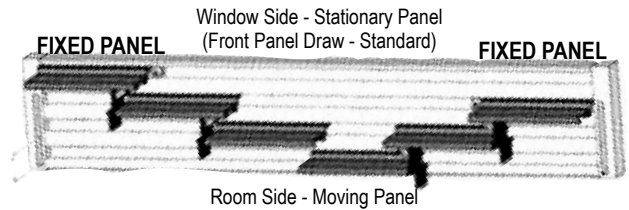

- 4 Channels - Split Draw - Wand Control
 6 Panels
 Minimum Track Width is 75"
 Maximum Track Width is 192"
 Number of Overlaps: 5

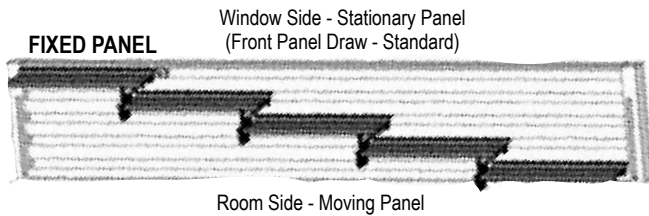

- 5 Channels - One Way Draw
 5 Panels
 Minimum Track Width is 63"
 Maximum Track Width is 192"
 Number of Overlaps: 4

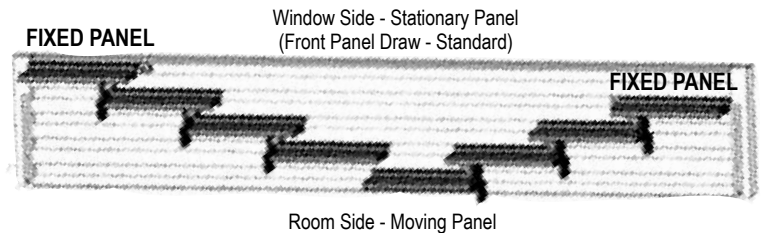

- 5 Channels - Split Draw - Wand or Cord Control
 All Split Draw with Cord Control utilize a 5 Channel track
 8 Panels
 Minimum Track Width is 99"
 Maximum Track Width is 192"
 Number of Overlaps: 7

Product Information

Panel Track

Approximate Panel Size Tables based upon Panels and Overlaps

Panel Width cannot be specified.

Panel Sizes given are approximate and based upon Outside Measure/Mount

2 Panels / 1 Overlap

Panel Min.	Panel Max.	Window Min.	Window Max.
15"	16"	27"	29"
16 1/16"	17"	29 1/8"	31"
17 1/16"	18"	31 1/8"	33"
18 1/16"	19"	33 1/8"	35"
19 1/16"	20"	35 1/8"	37"
20 1/16"	21"	37 1/8"	39"
21 1/16"	22"	39 1/8"	41"
22 1/16"	23"	41 1/8"	43"
23 1/16"	24"	43 1/8"	45"
24 1/16"	25"	45 1/8"	47"
25 1/16"	26"	47 1/8"	49"
26 1/16"	27"	49 1/8"	51"
27 1/16"	28"	51 1/8"	53"
28 1/16"	29"	53 1/8"	55"
29 1/16"	30"	55 1/8"	57"
30 1/16"	31"	57 1/8"	59"
31 1/16"	32"	59 1/8"	61"
32 1/16"	33"	61 1/8"	63"
33 1/16"	34"	63 1/8"	65"
34 1/16"	35"	65 1/8"	67"
35 1/16"	36"	67 1/8"	69"
36 1/16"	37"	69 1/8"	71"
37 1/16"	38"	71 1/8"	73"
38 1/16"	39"	73 1/8"	75"
39 1/16"	40"	75 1/8"	77"
40 1/16"	41"	77 1/8"	79"

4 Panels / 3 Overlaps

Panel Min.	Panel Max.	Window Min.	Window Max.
15"	16"	51"	55"
16 1/16"	17"	55 1/8"	59"
17 1/16"	18"	59 1/8"	63"
18 1/16"	19"	63 1/8"	67"
19 1/16"	20"	67 1/8"	71"
20 1/16"	21"	71 1/8"	75"
21 1/16"	22"	75 1/8"	79"
22 1/16"	23"	79 1/8"	83"
23 1/16"	24"	83 1/8"	87"
24 1/16"	25"	87 1/8"	91"
25 1/16"	26"	91 1/8"	95"
26 1/16"	27"	95 1/8"	99"
27 1/16"	28"	99 1/8"	103"
28 1/16"	29"	103 1/8"	107"
29 1/16"	30"	107 1/8"	111"
30 1/16"	31"	111 1/8"	115"
31 1/16"	32"	115 1/8"	119"
32 1/16"	33"	119 1/8"	123"
33 1/16"	34"	123 1/8"	127"
34 1/16"	35"	127 1/8"	131"
35 1/16"	36"	131 1/8"	135"
36 1/16"	37"	135 1/8"	139"
37 1/16"	38"	139 1/8"	143"
38 1/16"	39"	143 1/8"	147"
39 1/16"	40"	147 1/8"	151"
40 1/16"	41"	151 1/8"	155"

6 Panels / 5 Overlaps

Split Draw Only

Panel Min.	Panel Max.	Window Min.	Window Max.
15"	16"	75"	81"
16 1/16"	17"	81 1/4"	87"
17 1/16"	18"	87 1/4"	93"
18 1/16"	19"	93 1/4"	99"
19 1/16"	20"	99 1/4"	105"
20 1/16"	21"	105 1/4"	111"
21 1/16"	22"	111 1/4"	117"
22 1/16"	23"	117 1/4"	123"
23 1/16"	24"	123 1/4"	129"
24 1/16"	25"	129 1/4"	135"
25 1/16"	26"	135 1/4"	141"
26 1/16"	27"	141 1/4"	147"
27 1/16"	28"	147 1/4"	153"
28 1/16"	29"	153 1/4"	159"
29 1/16"	30"	159 1/4"	165"
30 1/16"	31"	165 1/4"	171"
31 1/16"	32"	171 1/4"	177"
32 1/16"	33"	177 1/4"	183"
33 1/16"	34"	183 1/4"	189"
34 1/16"	35"	189 1/4"	192"

3 Panels / 2 Overlaps

Panel Min.	Panel Max.	Window Min.	Window Max.
15"	16"	39"	42"
16 1/16"	17"	42 1/8"	45"
17 1/16"	18"	45 1/8"	48"
18 1/16"	19"	48 1/8"	51"
19 1/16"	20"	51 1/8"	54"
20 1/16"	21"	54 1/8"	57"
21 1/16"	22"	57 1/8"	60"
22 1/16"	23"	60 1/8"	63"
23 1/16"	24"	63 1/8"	66"
24 1/16"	25"	66 1/8"	69"
25 1/16"	26"	69 1/8"	72"
26 1/16"	27"	72 1/8"	75"
27 1/16"	28"	75 1/8"	78"
28 1/16"	29"	78 1/8"	81"
29 1/16"	30"	81 1/8"	84"
30 1/16"	31"	84 1/8"	87"
31 1/16"	32"	87 1/8"	90"
32 1/16"	33"	90 1/8"	93"
33 1/16"	34"	93 1/8"	96"
34 1/16"	35"	96 1/8"	99"
35 1/16"	36"	99 1/8"	102"
36 1/16"	37"	102 1/8"	105"
37 1/16"	38"	105 1/8"	108"
38 1/16"	39"	108 1/8"	111"
39 1/16"	40"	111 1/8"	114"
40 1/16"	41"	114 1/8"	117"

5 Panels / 4 Overlaps

Panel Min.	Panel Max.	Window Min.	Window Max.
15"	16"	63"	68"
16 1/16"	17"	68 1/8"	73"
17 1/16"	18"	73 1/8"	78"
18 1/16"	19"	78 1/8"	83"
19 1/16"	20"	83 1/8"	88"
20 1/16"	21"	88 1/8"	93"
21 1/16"	22"	93 1/8"	98"
22 1/16"	23"	98 1/8"	103"
23 1/16"	24"	103 1/8"	108"
24 1/16"	25"	108 1/8"	113"
25 1/16"	26"	113 1/8"	118"
26 1/16"	27"	118 1/8"	123"
27 1/16"	28"	123 1/8"	128"
28 1/16"	29"	128 1/8"	133"
29 1/16"	30"	133 1/8"	138"
30 1/16"	31"	138 1/8"	143"
31 1/16"	32"	143 1/8"	148"
32 1/16"	33"	148 1/8"	153"
33 1/16"	34"	153 1/8"	158"
34 1/16"	35"	158 1/8"	163"
35 1/16"	36"	163 1/8"	168"
36 1/16"	37"	168 1/8"	173"
37 1/16"	38"	173 1/8"	178"
38 1/16"	39"	178 1/8"	183"
39 1/16"	40"	183 1/8"	188"
40 1/16"	41"	188 1/8"	192"

8 Panels / 7 Overlaps

Split Draw Only

Panel Min.	Panel Max.	Window Min.	Window Max.
15"	16"	99"	107"
16 1/16"	17"	107 1/4"	115"
17 1/16"	18"	115 1/4"	123"
18 1/16"	19"	123 1/4"	131"
19 1/16"	20"	131 1/4"	139"
20 1/16"	21"	139 1/4"	147"
21 1/16"	22"	147 1/4"	155"
22 1/16"	23"	155 1/4"	163"
23 1/16"	24"	163 1/4"	171"
24 1/16"	25"	171 1/4"	179"
25 1/16"	26"	179 1/4"	187"
26 1/16"	27"	187 1/4"	192"

One Way Stacking Width = Panel Width

Split Draw Stacking Width = Panel Width x 2

Design Options

Panel Track - Valances, Measuring & Brackets

Majesty, Noble, or Camelot Wood Valance

- Valances are available in 14 colors: Accessible Beige, Buckeye, Cottage Pine, Ebony Wash, Gardenia, Harmony, Java Roast, Mahogany, Moonshine, Natural, Navajo White, Revere Pewter, Snow White, Thunder. Sample chips are available using MySwatch.
- Standard return is 3 1/2" for 3 channels from back of valance to wall; 4 1/2" for 4 channels and 5 1/2" for 5 channels.
- If wood valance width is over 96" the valance will be spliced.
- L Bracket with panhead nut & bolt is used for attachment through the top of the dust cover.

Majesty Valance
4 1/2" height
5/8" thick

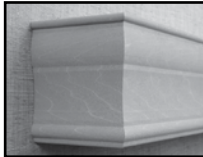

Noble Valance
4 5/8" height
1/2" thick



Camelot Valance
3 1/2" height
1/2" thick

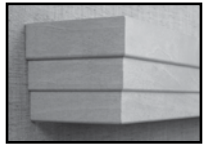

Artisan Valance

- Available in White, Black, Satin Nickel and Pewter.
- Profile Height: 3"
- Maximum width: 144"
- Valance clips on to Panel Track channel.
- Select Corner Connector color: White, Black or Gray.
- Specify return size for outside mount shades.

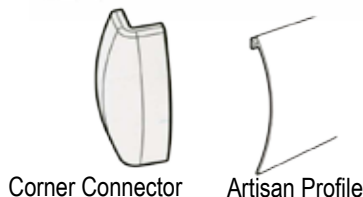
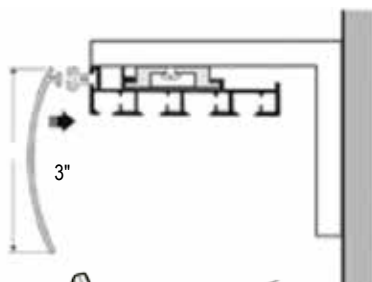

Corner Connector

Artisan Profile



Artisan Pewter Valance with
Black Corner Connector

Best Practices for Measuring

- Always use a steel tape or a metal ruler for measuring.
- Always measure every window even though they look the same.
- Check for obstructions that could affect operation of the shade.
- For Inside Mount (jamb to jamb in a window or door, wall to wall in a room), give exact inside to inside width measurements, and top to bottom length measurements of the area to be covered.
- Measure the width in at least three places and specify the narrowest width.
- Measure the length in at least three places and specify the shortest length.
- Take two diagonal measurements. If there is a greater than 3/8" difference in diagonal measurements, outside mount is strongly recommended to avoid irregular light gaps.
- For Outside Mount, measure the exact width and height of the area to be covered.

Panel Track Measuring

- All shade pricing is based on the width and the height.
- Panel Track orders are accepted for either inside or outside dimensions.
- There WILL BE a 1/2" **LIGHT GAP** on the left and right sides. Consider drapery panels on each side of the opening to conceal the light gap with the inside mount installation.
- Shade width measurements should be taken to the nearest 1/16".
- It is critical that the shade brackets be mounted so that the shade is level when installed.
- For an Inside Mount, For Panel Track to be installed inside an area (jamb to jamb in a window or door, wall to wall in a room), give exact inside width measurements, and top to bottom length measurements of the area to be covered.
- For an Outside Mount, measure the exact width and height of the area to be covered.
- For an Outside Mount, when measuring to cover a window, we recommend the Panel Track overlap the window by 3" to 6" on each side for privacy and light control.
- For Length, measure the full length of the window opening from the top frame to the bottom coverage point) to determine your window length. When installing a Panel Track above the window frame, the track should be installed at least 2" above the frame or molding to allow the foot of the installation bracket to be properly mounted.
- When measuring from the ceiling to the floor, a deduction of 1/2" to 3/4" is recommended, **but you must make this deduction.**
- Finished Dimensions are given on [page 76](#).

Brackets

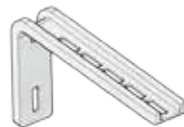

Installation L Brackets
Colors Black-03, White-11, Silver-12

- 3 Channel - Item PT-301-XX
4" deep, 2 1/4" high, 1" wide
- 4 Channel - Item PT-302-XX
4 23/32" deep, 2 1/4" high, 1" wide
- 5 Channel - Item PT-303-XX
4 5/8" deep, 2 1/4" high, 1" wide



Inside Mount Bracket

- White
Item PT-6535-011
1 3/8" deep" x 1 1/8" deep

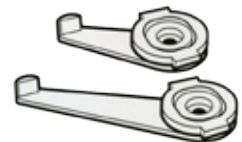

Swivel bracket for Inside Mount
Colors Black-003, White-001, Gray-090

- 3 channel, 2 1/4" deep
Item PT-6519-XXX
- 4 or 5 channel, 3 3/8" deep
Item PT-6520-XXX

Terminology

OPACITY RATINGS

Different fabrics allow varying amounts of light into the room and provide different levels of privacy. Fabrics are generally classified in one of five categories; Sheer, Semi-Sheer, Semi-Opaque, Private and Opaque.

- 1 - Sheer - Allows light to enter while reducing glare.
- 2 - Semi-Sheer - Allows soft diffused light, moderate privacy
- 3 - Semi-Opaque - Allows only filtered light inside. Provides substantial privacy.
- 4 - Private - Filters more light, blocks view. Provides complete privacy.
- 5 - Opaque - Blocks 99% of light. Complete privacy and greatest light control.

Warning: Even though a material may be rated "opaque", an inside application will have light leakage on the sides.

DESIGNATIONS / CERTIFICATIONS

- **GreenAssured®**: GreenAssured is ITA's proprietary certification program for environmentally compatible window fashion products with their brand. The program is supported by independent laboratory testing, using internationally recognized, officially sanctioned protocols. To become certified products must meet strict environmental criteria including airborne chemical emissions and the ecological impacts of the sourcing of raw materials, especially wood. ITA, Inc. developed and implemented the GreenAssured program in response to growing international awareness and concern about the effects of household products on indoor air quality, and the impact on local ecological systems of harvesting endangered or threatened species of trees for wood-based products. Both hard and soft window covering materials are tested for emissions of airborne chemicals cited by the U.S. Environmental Protection Agency (EPA) as dangerous to health and safety under the Superfund Amendments and Reauthorization Act, Section 313 (SARA 313), as well as particulates, other potentially harmful substances, and recyclability. To achieve certification, products must comply with emissions limitations and other standards such as: Total aldehydes, including formaldehyde; Volatile organic compounds (VOCs); Respirable particulates; Heat induced off-gas emissions.
- **GREENGUARD** Certification Program: GREENGUARD Certification (formerly known as GREENGUARD Indoor Air Quality Certification) gives assurance that products designed for use in indoor spaces meet strict chemical emissions limits, which contribute to healthier interiors. Achieving GREENGUARD Certification gives credence to manufacturers' sustainability claims, backing them with empirical scientific data from an unbiased, third-party organization. See greenguard.org for allowable emission levels and exposure modeling information.
- **GREENGUARD Gold Certification Program** (formerly known as GREENGUARD for Children and SchoolsSM): offers stricter certification criteria, considers safety factors to account for sensitive individuals (such as children and the elderly), and ensures that a product is acceptable for use in environments such as schools and healthcare facilities. It is referenced by both The Collaborative for High Performance School (CHPS) and the Leadership in Energy and Environmental Design (LEED) Building Rating System. See greenguard.org for Chronic Reference Exposure Levels (CRELs).
- **KOOLBLACK®** Technology is a patented technology that enhances dark colored fabric's heat reflectivity by increasing its near infrared reflection (NIR). While conventional dark screen fabric provides superior view through and exceptional glare control, it absorbs the energy that is created by near infrared wavelength. A dark screen fabric with KOOLBLACK® Technology enables the fabric to reflect more solar heat, therefore, absorb less energy. As a result, KOOLBLACK® Technology increases the energy efficiency of dark solar shade fabrics to levels comparable with light colors. Only dark solar shade fabrics with KOOLBLACK® Technology provide exceptional glare control, comfortable view through and elegant streetside aesthetics while reducing heat.
- **Oeko-Tex™ 100, Confidence in Textiles**: The Oeko-Tex Standard 100 provides the textile and clothing industry with a globally uniform standard for the objective assessment of harmful substances. Raw materials, intermediate and end products at all stages of processing throughout the manufacturing chain, including accessories, are tested and certified. Certification is obtained by application in writing from the manufacturer to one of the authorized test institutes or official offices around the globe. The samples submitted are tested exclusively in the member institutes in Europe and Japan in order to ensure a consistently high level of testing. The mark "Confidence in Textiles - Test for harmful substances according to Oeko-Text Standard 100" states that the marked product fulfills the conditions specified in this standard, are under the supervision of an institute belonging to the International Association for Research and Testing in the field of Textile Ecology (Oeko-Tex). The mark is not a quality label. The mark relates only to the as-produced state of the textile and says nothing about other properties of the product such as e.g. fitness for use, reaction to cleaning processes, physiological behavior in respect to clothing, properties relating to use in buildings, burning behavior etc. This mark does not declare anything about harmful substances affecting single specimens of the marked textile as a result of damage during transportation or storing (and improper cleaning procedures thereafter), contamination caused by manipulation for sales promotion (e.g. perfuming) and inadequate sales display.

**Technical Specifications and Fenestration Data can be found online at
www.lafayetteinteriorfashions.com/Dealer Center/Products/Genesis.**

Glossary

CLOTH WIDTH MEASURE (CM): The exact width of the cloth from the left vertical edge to the right vertical edge of the material.

INSIDE MOUNT (IS): When a window covering is mounted within the window casing opening. For recommended measurement practices see [page 68](#) for window shades or [page 75](#) for roman shades or [page 79 for Panel Track](#).

LIGHT GAP: The gap between the shade fabric (in the closed position) and the window casing. On inside mount installations the light gap would be the distance between the vertical edge of the fabric and the interior vertical edge of the window casing.

MINIMUM MOUNTING DEPTH - FLUSH MOUNT: The smallest measurement required for the shade product to be fully recessed within the window casing on an inside mount. Note: Some shade products have decorative features which are not included within the flush mount measurement.

MINIMUM MOUNTING DEPTH: The smallest measurement required by the mounting hardware to install the product for an inside mount. The product may have some projection into the room.

OPENNESS FACTOR: Refers to the ratio of open or interstice area to the total flat surface area of a perforated material. This quantity relates well to the amount of solar heat emitted through a fabric or perforated material and to the extent to which discomfort results to individuals near the window. It is usually expressed as a percentage or decimal portion of a total unit of 1.00.

OUTSIDE MOUNT (OS): When a window covering is mounted beyond or above the window casing (such as on a room facing wall). For recommended measurement practices see [page 68](#) for window shades or [page 75](#) for roman shades or [page 79 for Panel Track](#).

PROJECTION: The measurement from the mounting surface to the center of the bracket pin hole, which generally coincides with the center of the roller tube.

RAILROADED MATERIAL: The shade fabric is turned on its side, using width for length, to increase the maximum width available. Some fabrics cannot be railroaded due to pattern or construction. See [pages 3-4](#) to determine if shade materials can be railroaded.

REGULAR ROLL: The shade material pulls off of the roller tube from the back (window side) of the shade. The regular roll shade is the standard.

REVERSE ROLL: The shade material pulls off of the roller tube from the front (room side) of the shade. The reverse roll shade can provide additional clearance to window hardware on an inside mount or window casing/trim on an outside mount. The reverse roll shade will increase the light gap on many outside mount applications.

SPEARLINING: The aligning of more than one roman shade so the material is placed on the same spot on each roman shade. For window shades, spearlining is only available when a clutch is used. Pattern match is not guaranteed for window shades.

WINDOW HEIGHT: The height of the opening from the top of the window to the bottom (sill). This is also referred to as Window Length.

Product Information

Window Shade Color Coordination

Fabric	Color	Color #	SL Clutch	Cassette	Sure-Lift	Auto-Wand	Deck/ Swatch	Fabric	Color	Color #	SL Clutch	Cassette	Sure-Lift	Auto-Wand	Deck/ Swatch
Adele	Ash	044	Vanilla	Brsh Nckl	Brsh Nckl	Gray	3-53	Jackson	Rosewood	785	Vanilla	Sierra Tan	Vanilla	White	1-23
Adele	Winter	898	White	White	White	White	3-8	Jackson	Spa	806	Vanilla	Vanilla	Vanilla	White	1-29
Aedan	Berber	076	Vanilla	Vanilla	Vanilla	White	1-28	Jackson	Taupe	840	Vanilla	Sierra Tan	Vanilla	White	1-25
Aedan	Linen	455	Vanilla	Sierra Tan	Vanilla	White	1-18	Jackson	Tearose	842	Vanilla	Sierra Tan	Vanilla	White	1-20
Beatty	Mink	216	Black	Bronze	Bronze	Black	1-41	Katrina	White	885	White	White	White	White	3-17
Berber Slub	Pebble	610	Vanilla	Brsh Nckl	Brsh Nckl	Gray	3-22	Keilani	Conch	213	Vanilla	Vanilla	Vanilla	White	1-6
Berber Slub	Stone	820	Vanilla	Brsh Nckl	Brsh Nckl	Gray	3-43	Keilani	Raffia	731	Vanilla	Vanilla	Vanilla	White	1-19
Berber Slub	Winter	898	Vanilla	Brsh Nckl	Brsh Nckl	Gray	3-1	Kendo	Bamboo	006	Vanilla	Sierra Tan	Vanilla	White	1-22
Boho	Cotton	911	White	White	White	White	3-13	Kendo	Tortoise Shell	119	Vanilla	Sierra Tan	Bronze	White	1-34
Boucle	Alabaster	001	Vanilla	Vanilla	Vanilla	White	4-23	Lexie	Buff	130	Vanilla	Vanilla	Vanilla	White	3-6
Brit	Coffee	217	Black	Bronze	Bronze	Black	S-3	Lexie	Pebble	610	Vanilla	Brsh Nckl	Brsh Nckl	Gray	3-25
Brit	Taupe	840	Vanilla	Sierra Tan	Vanilla	White	S-3	Lexie	White	885	White	White	White	White	3-5
Cabos	Cloud	904	Vanilla	Brsh Nckl	Brsh Nckl	Gray	1A-1	Light-Vue	Bronze	027	Black	Bronze	Bronze	Black	S-1
Cabos	Griege	067	Vanilla	Vanilla	Vanilla	White	1A-17	Light-Vue	Smoke	028	Black	Black	Bronze	Black	S-1
Cabos	Sand	041	Vanilla	Vanilla	Vanilla	White	1-12	Light-Vue	Smoke/Ice	035	Black	Black	Bronze	Black	S-1
Cabos	Shell	760	Vanilla	Vanilla	Vanilla	White	1-3	Lindley	Linen	455	Vanilla	Sierra Tan	Vanilla	White	4-28
Cayman	Onyx	562	Black	Bronze	Bronze	Black	1-39	Lindley	Pumice	607	White	Brsh Nckl	Brsh Nckl	Gray	4-54
Cayman	Sunny	016	Vanilla	Vanilla	Vanilla	White	1-16	Lindley	White	885	White	White	White	Pumice	4-1
Charmed	Nile	555	Black	Bronze	Bronze	Black	2-24	Linen	Flax	340	Vanilla	Vanilla	Vanilla	White	4-7
Dakota	Slate	800	Vanilla	Brsh Nckl	Brsh Nckl	Gray	1A-33	Linen	Parchment	580	Vanilla	Vanilla	Vanilla	White	4-35
Dallas	Silver	780	Vanilla	Brsh Nckl	Brsh Nckl	Gray	3A-44	Lizzy	Citrus	845	Vanilla	Vanilla	Vanilla	White	3B-1
Dallas	Storm	823	Vanilla	Brsh Nckl	Brsh Nckl	Gray	3A-46	Lizzy	Teal	172	Vanilla	Vanilla	Vanilla	White	3B-1
Deco Screen	Parchment	580	White	White	White	White	S-2	Long Bay	Earth	312	Vanilla	Sierra Tan	Bronzed	White	3-29
Dimensions 3% & 5%	Cappuccino	148	Black	Sierra Tan	Bronze	Black	S-5	Long Bay	Elements	139	Vanilla	Vanilla	Vanilla	White	3-50
Dimensions 3% & 5%	Charcoal	185	Black	Black	Bronze	Black	S-5	Long Bay	Ivory	420	Vanilla	Vanilla	Vanilla	White	3-12
Dimensions 3% & 5%	Cocoa	208	Black	Black	Bronze	Black	S-5	Long Bay	Mineral	701	Vanilla	Brsh Nckl	Brsh Nckl	Gray	3-51
Dimensions 3% & 5%	Linen	455	Vanilla	Vanilla	Vanilla	White	S-5	Long Bay	Sand	725	Vanilla	Sierra Tan	Vanilla	White	3-28
Dimensions 3% & 5%	Pebble	610	Vanilla	Vanilla	Vanilla	White	S-5	Long Bay Blackout	Barley	012	Vanilla	Vanilla	Vanilla	White	4-8
Dimensions 3% & 5%	Sable	714	Black	Bronze	Bronze	Black	S-5	Long Bay Blackout	Stone	820	Vanilla	Vanilla	Vanilla	White	4-36
Dimensions 3% & 5%	Stone	820	Vanilla	Vanilla	Vanilla	White	S-5	Loretta	Tan	836	Black	Bronze	Bronze	Black	3-38
Dimensions 3% & 5%	White	885	White	White	White	White	S-5	Lucinda	Tan	836	Vanilla	Sierra Tan	Vanilla	White	3-37
Duo Vue	Chocolate	423	Black	Bronze	Bronze	Black	S-1	Luminescence	Antiquity	026	Vanilla	Vanilla	Vanilla	White	-22
Duo Vue	Sand	725	Vanilla	Vanilla	Vanilla	White	S-1	Luminescence	Bronze	122	Black	Bronze	Bronze	Black	2-7
Duo Vue	Silver Sand	098	Vanilla	Brsh Nckl	Brsh Nckl	Gray	S-1	Luminescence	Gun Metal	815	Vanilla	Brsh Nckl	Brsh Nckl	Gray	2-16
E Screen 3% and 5%	Apricot	040	Black	Bronze	Bronze	Black	S-5	Luminescence	Pearl	605	Vanilla	Vanilla	Vanilla	White	2-1
E Screen 3% and 5%	Bronze	122	Black	Bronze	Bronze	Black	S-5	Luminescence	Sterling	821	Vanilla	Brsh Nckl	Brsh Nckl	Gray	2-17
E Screen 3% and 5%	Charcoal	185	Black	Black	Bronze	Black	S-5	Lux Screen	Silver Beige	782	Vanilla	Brsh Nckl	Brsh Nckl	Gray	5U
E Screen 3% and 5%	Gray	385	Black	Black	Bronze	Black	S-5	Lux Screen	White Silver	887	Vanilla	Brsh Nckl	Brsh Nckl	Gray	5U
E Screen 3% and 5%	Linen	455	Vanilla	Vanilla	Vanilla	Black	S-5	Lux Screen	White Smoke	892	Vanilla	Brsh Nckl	Brsh Nckl	Gray	5U
E Screen 3% and 5%	Pearl	605	Vanilla	Brsh Nckl	Brsh Nckl	White	S-5	Moire	White	011	White	White	White	White	4-22
E Screen 3% and 5%	White	885	White	White	White	White	S-5	Mystic	Buff	130	Vanilla	Vanilla	Vanilla	White	2-5
E Screen 3% and 5% KOOLBLACK								Mystic	Canyon	162	Black	Bronze	Bronze	Black	2-13
	Char/Apricot	040	Black	Bronze	Bronze	Black	S-1	Mystic	Chestnut	176	Black	Bronze	Bronze	Black	2-14
	Char/Charcoal	185	Black	Black	Bronze	Black	S-1	Mystic	Chocolate	423	Black	Bronze	Bronze	Black	2-15
	Char/Cocoa	208	Black	Bronze	Bronze	Black	S-1	Mystic	Ice White	413	White	White	White	White	2A-1
Fedora	Flaxen	341	Vanilla	Sierra Tan	Vanilla	White	3A-34	Mystic	Lagoon	433	Black	Bronze	Bronze	Black	2-19
Fedora	Natural	540	Vanilla	Vanilla	Vanilla	White	3A-37	Mystic	Marble	535	Vanilla	Vanilla	Vanilla	White	2-4
Fedora	Tweed	217	Vanilla	Vanilla	Vanilla	White	3-39	Mystic	Pecan	615	Black	Bronze	Bronze	Black	2-12
Fiberlucet	Oyster	003	Vanilla	Vanilla	Vanilla	White	3-21	Mystic	Rice	690	Vanilla	Vanilla	Vanilla	White	2-6
Fiberlucet	White	011	White	White	White	White	3-20	Mystic	Slate	800	Black	Brsh Nckl	Brsh Nckl	Gray	2-22
Flutter	Ash	044	Vanilla	Brsh Nckl	Brsh Nckl	White	2A-16	Mystic	Topaz	769	Vanilla	Brsh Nckl	Brsh Nckl	Gray	2-21
Flutter	Ice White	413	White	White	White	White	2A-1A	Mystic	Travertine	767	Vanilla	Vanilla	Vanilla	White	2-23
Flutter	Ivory	420	Vanilla	Vanilla	Vanilla	White	2A-7	Mystic Eclipse	Chestnut	176	Black	Bronze	Bronze	Black	2A-14
Garbo	Anthracite	239	Vanilla	Brsh Nckl	Brsh Nckl	Gray	2B-16	Mystic Eclipse	Chocolate	423	Black	Bronze	Bronze	Black	2A-15
Garbo	Grey	809	Vanilla	Brsh Nckl	Brsh Nckl	Gray	2-20	Mystic Eclipse	Marble	535	Vanilla	Vanilla	Vanilla	White	2A-4
Garbo	Oyster	012	Vanilla	Vanilla	Vanilla	White	2B-1	Mystic Eclipse	Pecan	615	Black	Bronze	Bronze	White	2-11
Grasscloth	Linen	455	Vanilla	Vanilla	Vanilla	White	3-10	Mystic Eclipse	Rice	690	Vanilla	Vanilla	Vanilla	White	2A-6
Grasscloth	Nickel	111	Vanilla	Brsh Nckl	Brsh Nckl	Gray	3A-45	Net 3000	Bone	066	Vanilla	Vanilla	Vanilla	White	S-6
Grasscloth	Snow	805	White	White	White	White	3-3	Net 3000	Bronze	122	Black	Bronze	Bronze	Black	S-6
Harper	Sand	725	Vanilla	Sierra Tan	Vanilla	White	3-30	Net 3000	Charcoal	185	Black	Black	Bronze	Black	S-6
Highland	Cocoa	208	Black	Bronze	Bronze	Black	4-63	Net 3000	Pearl	001	White	White	White	White	S-6
Highland	Latte	463	Vanilla	Vanilla	Vanilla	White	4-42	Net 3000	Sand	041	Vanilla	Sierra Tan	Vanilla	White	S-6
Highland	Seal	944	Black	Bronze	Bronze	Black	4-62	Net 3000	Silver	062	Vanilla	Brsh Nckl	Brsh Nckl	Gray	S-6
Hombre	Berber	076	Black	Bronze	Bronze	Black	1-32	Net 3000	Silver Sand	098	Vanilla	Brsh Nckl	Brsh Nckl	Gray	S-6
Hombre	Flax	340	Vanilla	Vanilla	Vanilla	White	1-30	No Lite Fiberglass Duplex	Black	090	Black	Black	Bronze	Black	4-71
Hombre	Linen	455	Vanilla	Vanilla	Vanilla	White	1-21	No Lite Fiberglass Duplex	Cameo	047	Vanilla	Vanilla	Vanilla	White	4-52
Homespun	Flax	340	Vanilla	Vanilla	Vanilla	White	1-14								
Homespun	White	885	White	White	White	White	1-2								

Product Information

Window Shade Color Coordination

<i>Fabric</i>	<i>Color</i>	<i>Color #</i>	<i>SL Clutch</i>	<i>Cassette</i>	<i>Sure-Lift</i>	<i>Auto-Wand</i>	<i>Deck/Swath</i>	<i>Fabric</i>	<i>Color</i>	<i>Color #</i>	<i>SL Clutch</i>	<i>Cassette</i>	<i>Sure-Lift</i>	<i>Auto-Wand</i>	<i>Deck/Swath</i>
No Lite Fiberglass Duplex Cloud Gray		043	Vanilla	Brsh Nckl	Brsh Nckl	Gray	4-69	Scala Blackout	Black	090	Black	Black	Bronze	Black	MySwthc
No Lite Fiberglass Duplex Coffee		217	Black	Bronze	Bronze	Black	4-53	Scala Blackout	Dolphin Fin	391	White	White	Brsh Nckl	Gray	MySwthc
No Lite Fiberglass Solid Bone		120	Vanilla	Vanilla	Vanilla	White	4-27	Scala Blackout	Mocha Msse	536	Vanilla	Sierra Tan	Vanilla	White	MySwthc
No Lite Fiberglass Solid Champagne		170	Vanilla	Vanilla	Vanilla	White	4-51	Scala Blackout	White	885	White	White	White	White	MySwthc
No Lite Fiberglass Solid Cloud		904	White	White	White	White	4-25	Seclusion	White	011	White	White	White	White	4-20
No Lite Fiberglass Solid Oyster		003	Vanilla	Vanilla	Vanilla	White	4-50	Sedona	Driftwood	396	Vanilla	Brsh Nckl	Brsh Nckl	Gray	4-57
No Lite Fiberglass Solid Warm White		020	White	White	White	White	4-26	Sedona	Dune	017	Vanilla	Brsh Nckl	Brsh Nckl	Gray	4-56
No Lite Fiberglass Solid White		011	White	White	White	White	4-24	Sedona	Paperbark	179	Vanilla	Sierra Tan	Vanilla	White	4-29
Nordicscrn Plus BW (3%) Ash/Tan Stone 049		Vanilla	Brsh Nckl	Brsh Nckl	Gray	MySwthc		Sedona	Pumice	811	White	White	White	White	4-2
Nordicscrn Plus BW (3%) Black/Black		090	Black	Black	Bronze	Black	MySwthc	Serene	Alabaster	007	White	White	White	White	4-15
Nordicscrn Plus BW (3%) Mdnghl/Mag Strn692		Black	Black	Bronze	Black	MySwthc		Serene	Camel	139	Vanilla	Vanilla	Vanilla	White	4-43
Nordicscrn Plus BW (3%) Sable/Ash Pri		718	Black	Bronze	Bronze	Black	MySwthc	Serene	Cream	235	Vanilla	Vanilla	Vanilla	White	4-17
Nordicscrn Plus BW (3%) White/Gray		385	Vanilla	Brsh Nckl	Brsh Nckl	Gray	MySwthc	Serene	Linen	455	Vanilla	Vanilla	Vanilla	White	4-44
Nordicscrn Plus BW (3%) White/Linen		920	Vanilla	Vanilla	Vanilla	White	MySwthc	Serene	Slate	800	Vanilla	Brsh Nckl	Brsh Nckl	Gray	4-66
Nordicscrn Plus BW (3%) White/Sand		927	Vanilla	Sierra Tan	Vanilla	White	MySwthc	Serene	Truffle	857	Vanilla	Bronze	Bronze	Black	4-64
Nordicscrn Plus BW (3%) White/White		885	White	White	White	White	MySwthc	Serene	Vanilla	350	Vanilla	Vanilla	Vanilla	White	4-16
Nordicscrn Plus BW (3%) Wht/Wht Pri		902	White	White	White	White	MySwthc	Seto 5000	Charcoal	185	Black	Bronze	Bronze	Black	3-35
Nordicscrn Plus BW (5%) Ash/Tan Stone 049		Vanilla	Brsh Nckl	Brsh Nckl	Gray	MySwthc		Seto 5000	Ivory	420	Vanilla	Vanilla	Vanilla	White	3-15
Nordicscrn Plus BW (5%) Black/Black		090	Black	Black	Bronze	Black	MySwthc	Seto 6000	Haze	393	Vanilla	Brsh Nckl	Brsh Nckl	Gray	3-47
Nordicscrn Plus BW (5%) Black/Pearl		390	Black	Black	Bronze	Black	MySwthc	Seto 6000	White	011	White	White	White	White	3-7
Nordicscrn Plus BW (5%) Mdnghl/Tan Strn698		Black	Black	Bronze	Black	MySwthc		Shantung	Arctic White	011	White	White	White	White	1-4
Nordicscrn Plus BW (5%) Sable/Shale		220	Black	Bronze	Bronze	Black	MySwthc	Shantung	Natural	540	Vanilla	Vanilla	Vanilla	White	1-10
Nordicscrn Plus BW (5%) White/Gray		385	Vanilla	Brsh Nckl	Brsh Nckl	Gray	MySwthc	SheerWeave 1000	Pearl	001	White	White	White	White	S-4
Nordicscrn Plus BW (5%) White/Linen		920	Vanilla	Vanilla	Vanilla	White	MySwthc	SheerWeave 2000	Bone	066	Vanilla	Sierra Tan	Vanilla	White	S-6
Nordicscrn Plus BW (5%) White/Sand		927	Vanilla	Sierra Tan	Vanilla	White	MySwthc	SheerWeave 2000	Bronze	122	Black	Bronze	Bronze	Black	S-6
Nordicscrn Plus BW (5%) White/White		885	White	White	White	White	MySwthc	SheerWeave 2000	Charcoal	185	Black	Black	Bronze	Black	S-6
Nordicscrn Plus BW (5%) Wht/Wht Pri		902	White	White	White	White	MySwthc	SheerWeave 2000	Gray	385	Black	Black	Bronze	Black	S-6
Nordicscrn Plus Twill (1%) Black/Black		090	Black	Black	Bronze	Black	MySwthc	SheerWeave 2000	Pearl	001	White	White	White	White	S-6
Nordicscrn Plus Twill (1%) Black/Pearl		390	Black	Black	Bronze	Black	MySwthc	SheerWeave 2000	Sand	041	Vanilla	Vanilla	Vanilla	White	S-6
Nordicscrn Plus Twill (1%) White/Black		916	Black	Black	Bronze	Black	MySwthc	SheerWeave 2000	Silver	062	Vanilla	Brsh Nckl	Brsh Nckl	Gray	S-6
Nordicscrn Plus Twill (1%) White/Bronze		919	Black	Bronze	Bronze	Black	MySwthc	SheerWeave 2000	Silver Sand	098	Vanilla	Brsh Nckl	Brsh Nckl	Gray	S-6
Nordicscrn Plus Twill (1%) White/Linen		920	Vanilla	Vanilla	Vanilla	White	MySwthc	SheerWeave 2390	Bronze	122	Black	Bronze	Bronze	Black	S-5
Nordicscrn Plus Twill (1%) White/Sand		927	Vanilla	Sierra Tan	Vanilla	White	MySwthc	SheerWeave 2390	Charcoal	185	Black	Black	Bronze	Black	S-5
Nordicscrn Plus Twill (1%) White/White		885	White	White	White	White	MySwthc	SheerWeave 2390	Gray	385	Black	Black	Bronze	Black	S-5
Nordicscrn Plus Twill (3%) White/Black		916	Black	Black	Bronze	Black	MySwthc	SheerWeave 2390	Pearl	605	White	White	White	White	S-5
Nordicscrn Plus Twill (3%) White/Bronze		919	Black	Bronze	Bronze	Black	MySwthc	SheerWeave 2390	Sand	725	Vanilla	Vanilla	Vanilla	White	S-5
Nordicscrn Plus Twill (3%) White/Linen		920	Vanilla	Vanilla	Vanilla	White	MySwthc	SheerWeave 2390	Silver	780	Vanilla	Brsh Nckl	Brsh Nckl	Gray	S-5
Nordicscrn Plus Twill (3%) White/Sand		927	Vanilla	Sierra Tan	Vanilla	White	MySwthc	SheerWeave Perf + 2390	Pearl	605	White	White	White	White	S-1
Opulence	Bronze	122	Black	Bronze	Bronze	Black	S-3	SheerWeave Perf + 2390	Sand	725	Vanilla	Vanilla	Vanilla	White	S-1
Opulence	Charcoal	185	Black	Black	Bronze	Black	S-3	SheerWeave Perf + 2390	Silver	780	Vanilla	Brsh Nckl	Brsh Nckl	Gray	S-1
Opulence	Enchanted	188	Black	Black	Bronze	Black	S-3	SheerWeave 2410	Bronze	122	Black	Bronze	Bronze	Black	S-5
Opulence	White	885	White	White	White	White	S-3	SheerWeave 2410	Charcoal	185	Black	Black	Bronze	Black	S-5
Origami	Bamboo	006	Vanilla	Vanilla	Vanilla	White	1-7	SheerWeave 2410	Gray	385	Black	Black	Bronze	Black	S-5
Pacifica	Flax	340	Vanilla	Vanilla	Vanilla	White	4-5	SheerWeave 2410	Pearl	605	White	White	White	White	S-5
Pacifica	Parchment	580	Vanilla	Sierra Tan	Vanilla	White	433	SheerWeave 2410	Sand	725	Vanilla	Vanilla	Vanilla	White	S-5
Palm Beach	Calico	111	Vanilla	Vanilla	Vanilla	White	4-38	SheerWeave 2410	Silver	780	Vanilla	Brsh Nckl	Brsh Nckl	Gray	S-5
Palm Beach	Eve	232	White	White	White	White	4-14	SheerWeave Perf + 2410	Pearl	605	White	White	White	White	S-1
Palm Beach	Jumbo	323	Black	Black	Bronze	Black	4-67	SheerWeave Perf + 2410	Sand	725	Vanilla	Vanilla	Vanilla	White	S-1
Pearlescent	Glacier	362	White	White	White	White	4-6	SheerWeave Perf + 2410	Silver	780	Vanilla	Brsh Nckl	Brsh Nckl	Gray	S-1
Pearlescent	Sand	041	Vanilla	Vanilla	Vanilla	White	4-34	SheerWeave 2500	Bronze	122	Black	Bronze	Bronze	Black	S-5
Persia	Onyx	562	Black	Black	Bronze	Black	1-38	SheerWeave 2500	Charcoal	185	Black	Black	Bronze	Black	S-5
Persia	Pecan	615	Black	Bronze	Bronze	Black	1-40	SheerWeave 2500	Gray	385	Black	Black	Bronze	Black	S-5
Petticoat	Cotton	911	White	White	White	White	3C-1	SheerWeave 2500	Pearl	605	White	White	White	White	S-5
Princeton	Beige	066	Vanilla	Vanilla	Vanilla	White	3-11	SheerWeave 2500	Sand	725	Vanilla	Vanilla	Vanilla	White	S-5
Princeton	Cappucino	148	Black	Bronze	Bronze	Black	3-26	SheerWeave 2500	Silver	780	Vanilla	Brsh Nckl	Brsh Nckl	Gray	S-5
Princeton	Espresso	331	Black	Bronze	Bronze	Black	3-27	SheerWeave 3000	Chocolate	047	Black	Bronze	Bronze	Black	S-4
Princeton	Platinum	655	Black	Brsh Nckl	Brsh Nckl	Gray	3-54	SheerWeave 3000	Custard Crm	239	Vanilla	Vanilla	Vanilla	White	S-4
Reserved	Latté	463	Vanilla	Vanilla	Vanilla	White	2-18	SheerWeave 3000	Granite	375	Black	Black	Bronze	Black	S-4
Reserved	Root	175	Black	Bronze	Bronze	Black	2-15A	SheerWeave 3000	Mushrm Sand	048	Vanilla	Sierra Tan	Vanilla	White	S-4
Rocky Mountain	Clay	198	Black	Bronze	Bronze	Black	1-44	SheerWeave 3000	Pale Gray	083	Vanilla	Brsh Nckl	Brsh Nckl	Gray	S-4
Rocky Mountain	Tan	836	Black	Bronze	Bronze	Black	1-42	SheerWeave 3000	Pearl White	011	White	White	White	White	S-4
Rocky Mountain	Walnut	891	Black	Bronze	Bronze	Black	1-45	SheerWeave 4100	Alabaster	007	White	White	White	White	S-4
Rollie	Berber	076	Black	Bronze	Bronze	Black	1-31	SheerWeave 4100	Chalk	011	White	White	White	White	S-4
S Screen Elements	Seasalt	658	Vanilla	Brsh Nckl	Brsh Nckl	Gray	S-2	SheerWeave 4100	Granite	375	Vanilla	Brsh Nckl	Brsh Nckl	Gray	S-4
S Screen Origins	Cork	102	Vanilla	Sierra Tan	Bronze	White	S-2	SheerWeave 4100	Pebble Stone	048	Vanilla	Vanilla	Vanilla	White	S-4
S Screen Origins	Marble	152	Vanilla	Brsh Nckl	Brsh Nckl	Gray	S-3	SheerWeave 4100	Silver Sand	098	Vanilla	Brsh Nckl	Brsh Nckl	Gray	S-4
Safari	Teak	758	Black	Bronze	Bronze	Black	1-46	SheerWeave 4100	Tobacco	047	Black	Black	Bronze	Black	S-4

Product Information

Window Shade Color Coordination

Fabric	Color	Color #	SL Clutch	Cassette	Sure-Lift	Auto-Wand	Deck/Switch
SheerWeave 4400	Alabaster	007	White	White	White	White	S-6
SheerWeave 4400	Pebble Stone	048	Vanilla	Sierra Tan	Vanilla	White	S-6
SheerWve 5000 Bamboo	Birch bark	141	Vanilla	Vanilla	Vanilla	White	S-2
SheerWve 5000 Bamboo	Wheat	880	Vanilla	Bronze	Bronze	Black	S-2
SheerWeave 5000 Bark	Ash	061	Vanilla	Brsh Nckl	Vanilla	Black	New
SheerWeave 5000 Bark	Pewter	062	Vanilla	Brsh Nckl	Vanilla	Black	New
SheerWeave 5000 Bark	Tiger-eye	843	Black	Sierra Tan	Bronze	Black	S-3
SheerWve 5000 Chenille	Driftwood	396	Black	Bronze	Bronze	Black	S-3
SheerWve 5000 Chenille	Honey	562	Vanilla	Vanilla	Vanilla	White	S-2
SheerWve 5000 Chenille	Marshmallow	089	Vanilla	Vanilla	Vanilla	White	S-2
SheerWve 5000 Hnycmb	Nugget	543	Black	Bronze	Bronze	Black	S-2
SheerWeave 5000 Jute	Parchment	580	Vanilla	Vanilla	Vanilla	White	S-2
SheerWeave 5000 Linen	Cinnamon	839	Black	Bronze	Bronze	Black	S-3
SheerWeave 5000 Linen	Clay	065	Vanilla	Brsh Nckl	Vanilla	Gray	New
SheerWeave 5000 Linen	Cranberry	233	Black	Bronze	Bronze	Black	S-3
SheerWeave 5000 Linen	Cream	235	Black	Sierra Tan	Vanilla	White	S-2
SheerWeave 5000 Linen	Fig	657	Black	Bronze	Bronze	Black	S-3
SheerWeave 5000 Linen	Pearl	063	Vanilla	Brsh Nckl	Vanilla	White	New
SheerWeave 5000 Linen	Taupe	064	Vanilla	Brsh Nckl	Vanilla	Gray	New
SheerWeave 5000 Marble	Sand	725	Black	Sierra Tan	Vanilla	White	S-2
SheerWeave 5000 Metro	Platinum	066	Vanilla	Brsh Nckl	Vanilla		New
SheerWeave 5000 Rattan	Umber	918	Black	Bronze	Bronze	Black	S-2
SheerWeave 5000 Tweed	Buckeye	095	Black	Bronze	Bronze	Black	S-3
SheerWeave 5000 Tweed	Oatmeal	094	Vanilla	Vanilla	Vanilla	White	S-2
SheerWeave 5000 Wicker	Mushroom	535	Black	Bronze	Bronze	Black	S-3
SheerWeave 5000 Wicker	Straw	825	Vanilla	Sierra Tan	Vanilla	White	S-2
SheerWeave 7000	Birchbark	141	Vanilla	Vanilla	Vanilla	White	4-39
SheerWeave 7000	Canyon	162	Vanilla	Brsh Nckl	Brsh Nckl	Gray	4-59
SheerWeave 7000	Graphite	983	Black	Black	Bronze	Black	4-60
SheerWeave 7000	Mushroom	535	Vanilla	Sierra Tan	Bronze	Black	4-41
SheerWeave 7000	Onyx	562	Black	Black	Bronze	Black	4-61
SheerWeave 7000	Sand	725	Vanilla	Vanilla	Vanilla	White	4-40
SheerWeave 7000	White	885	White	White	White	White	4-12
SheerWeave 7400	Cotton	911	Vanilla	Vanilla	Vanilla	Gwhite	4-3
SheerWeave 7400	Parchment	580	Vanilla	Vanilla	Vanilla	White	4-9
SheerWeave 7400	Pebble	610	Vanilla	Brsh Nckl	Brsh Nckl	Gray	4-4
SheerWeave 7400	Sesame	082	Black	Bronze	Bronze	Black	4-10
SheerWeave 7400	Shale	085	Vanilla	Brsh Nckl	Brsh Nckl	Gray	4-65
SheerWeave 7450	Parchment	580	Vanilla	Vanilla	Vanilla	White	3-33
SheerWeave 7450	Sesame	082	Black	Bronze	Bronze	Black	3-60
SheerWeave 7450	Shale	085	Vanilla	Brsh Nckl	Brsh Nckl	Gray	3-46
SheerWeave Infinity 2 3% and 5%							
	Almond	347	Vanilla	Vanilla	Vanilla	White	S-1
	Cotton	911	White	White	White	White	S-1
	Stone	820	Vanilla	Brsh Nckl	Brsh Nckl	Gray	S-1
Solar Screen 3000 (1%)	Brown/Choc	365	Black	Bronze	Bronze	Black	MySwitch
Solar Screen 3000 (1%)	Ebony	318	Black	Black	Bronze	Black	MySwitch
Solar Screen 3000 (1%)	Ebony/Pearl	317	Black	Black	Bronze	Black	MySwitch
Solar Screen 3000 (1%)	Linen	455	Vanilla	Vanilla	Vanilla	White	MySwitch
Solar Screen 3000 (1%)	White	885	White	White	White	White	MySwitch
Solar Screen 3000 (1%)	White/Linen	920	Vanilla	Vanilla	Vanilla	White	MySwitch
Solar Screen 3000 (1%)	White/Pearl	925	Vanilla	Brsh Nckl	Brsh Nckl	Gray	MySwitch
Solar Screen 3000 (3%)	Brown/Choc	365	Black	Bronze	Bronze	Black	MySwitch
Solar Screen 3000 (3%)	Ebony	318	Black	Black	Bronze	Black	MySwitch
Solar Screen 3000 (3%)	Ebony/Pearl	317	Black	Black	Bronze	Black	MySwitch
Solar Screen 3000 (3%)	Linen	455	Vanilla	Vanilla	Vanilla	White	MySwitch
Solar Screen 3000 (3%)	Taupe	840	Vanilla	Brsh Nckl	Brsh Nckl	Gray	MySwitch
Solar Screen 3000 (3%)	White	885	White	White	White	White	MySwitch
Solar Screen 3000 (3%)	White/Linen	920	Vanilla	Vanilla	Vanilla	White	MySwitch
Solar Screen 3000 (3%)	White/Pearl	925	Vanilla	Brsh Nckl	Brsh Nckl	Gray	MySwitch
Spector	Cobble	209	Black	Bronze	Bronze	Black	4A-62
Spector	Driftwood	396	Vanilla	Sierra Tan	Bronze	White	4-32
Spector	Granite	375	Black	Black	Bronze	Black	4-58
Spector	Grey Birch	386	Vanilla	Sierra Tan	Vanilla	White	4-31
Spector	Skimming Stn	822	Vanilla	Sierra Tan	Vanilla	White	4-30
Spector	TurtleDove	280	Vanilla	Brsh Nckl	Brsh Nckl	Gray	4-55
Spector	Vintage White	023	Vanilla	Vanilla	Vanilla	White	4-13
Spiral	Charcoal	185	Black	Black	Bronze	Black	3A-62
Spiral	Ivory	420	Vanilla	Vanilla	Vanilla	White	3A-9
Strata	Calico	111	Vanilla	Vanilla	Vanilla	White	3-31
Strata	Popplin	663	Vanilla	Vanilla	Vanilla	White	3-32
Strie	Cream	235	Vanilla	Brsh Nckl	Brsh Nckl	Gray	3-55
Strie	Pearl	605	White	White	White	White	3-14
Strie	Taupe	840	Vanilla	Vanilla	Vanilla	White	3-34
Superwide	Papyrus	303	Vanilla	Vanilla	Vanilla	White	4-19
Superwide	Sand	725	Vanilla	Vanilla	Vanilla	White	4-48
Superwide	White	011	White	White	White	White	4-18
T Screen Koolblack	White/Charcoal	185	Black	Black	Bronze	Black	S-1
T Screen Koolblack	White/Cocoa	208	Black	Bronze	Bronze	Black	S-1
T Screen Koolblack	White/Grey	385	Vanilla	Brsh Nckl	Brsh Nckl	Gray	S-1
Tahiti	Bone	020	Vanilla	Vanilla	Vanilla	White	1-13
Tahiti	Café Aulait	019	Vanilla	Vanilla	Vanilla	White	1-27
Tahiti	Shadow	756	Vanilla	Brsh Nckl	Brsh Nckl	Gray	1A-7
Triad	Alabaster	007	Vanilla	Vanilla	Vanilla	White	S-6
Triad	Charcoal	185	Black	Black	Bronze	Black	S-6
Triad	Pearl	605	White	White	White	White	S-6
Triad	Pebble stone	048	Vanilla	Sierra Tan	Vanilla	White	S-6
Triad	Silver Sand	098	Vanilla	Brsh Nckl	Brsh Nckl	Gray	S-6
Tussah	Charcoal	125	Black	Black	Bronze	Black	3-45
Tussah	Gray	385	Vanilla	Brsh Nckl	Brsh Nckl	Gray	3-44
Tussah	Latte	463	Black	Bronze	Bronze	Black	3-24
Tussah	Sterling	821	Vanilla	Brsh Nckl	Brsh Nckl	Gray	3-23
Tussah	White	885	White	White	White	White	3-4
Valencia	Khaki	436	Vanilla	Sierra Tan	Bronze	White	3-36
Valencia	Tweed	217	Vanilla	Brsh Nckl	Brsh Nckl	Gray	3-56
Viking	Black	008	Black	Black	Bronze	Black	3-62
Viking	Cream	080	Vanilla	Vanilla	Vanilla	White	3-40
Viking	Gray	385	Vanilla	Brsh Nckl	Brsh Nckl	Gray	3-61
Viking	Ivory	023	Vanilla	Vanilla	Vanilla	White	3-41
Viking	Tan	836	Vanilla	Vanilla	Vanilla	White	3-42
Viking	White	011	White	White	White	White	3-19
Vision	Chocolate	035	Black	Bronze	Bronze	Black	S-6
Vision	Ebony	318	Black	Black	Bronze	Black	S-6
Vision	Linen	455	Vanilla	Sierra Tan	Vanilla	White	S-6
Vision	White	885	White	White	White	White	S-6
Vista Screen	Grey	385	White	Brsh Nckl	Brsh Nckl	Gray	S-1
Vista Screen	Pearl	605	White	White	White	White	S-1
Vista Screen	Sand	725	Vanilla	Vanilla	Vanilla	White	S-1
Vista Screen	Silver Sand	098	White	Brsh Nckl	Brsh Nckl	Gray	S-1
Vizela	Blanc	105	White	White	White	White	3-2
Vizela	Loutre	609	Vanilla	Brsh Nckl	Brsh Nckl	Gray	3-52
Wave	Tawny	837	Vanilla	Vanilla	Vanilla	White	3-18
Weave	Berber	076	Vanilla	Brsh Nckl	Brsh Nckl	Gray	3-49
Weave	Cotton	911	White	White	White	White	3-9
Weave	Flax	340	Vanilla	Vanilla	Vanilla	White	3-48
Willow	Cloud	904	Vanilla	Brsh Nckl	Brsh Nckl	Gray	3-58
Willow	Granite	375	Vanilla	Brsh Nckl	Brsh Nckl	Gray	3-59
Willow	Shadow	756	Vanilla	Brsh Nckl	Brsh Nckl	Gray	3-57
Yellowstone	Clay	198	Black	Bronze	Bronze	Black	1-43
Yellowstone	Earth	312	Black	Bronze	Bronze	Black	1-36
Yellowstone	Mushroom	535	Black	Bronze	Bronze	Black	1-35
Yellowstone	Natural	540	Vanilla	Vanilla	Vanilla	White	1-26
Yellowstone	Walnut	891	Black	Bronze	Bronze	Black	1-37
Zootime	Carnival	164	White	White	White	White	1A-1



Midwest
Designer
Supply

www.midwestdesignersupply.com

888-523-2611
262-524-1007 (fax)